

U.S. Chart No. 1

Symbols, Abbreviations and Terms used on Paper and Electronic Navigational Charts



13th Edition
April 15, 2019

Prepared Jointly by

Department of Commerce
National Oceanic and Atmospheric Administration

Department of Defense
National Geospatial-Intelligence Agency



ECDIS Symbols and Other ECDIS Information

Symbology for displaying Electronic Navigational Charts (ENCs) on Electronic Chart Display and Information Systems (ECDIS) has been added to U.S. Chart No. 1. In addition to the ECDIS symbols shown in the traditional lettered sections of U.S. Chart No. 1, there are now several special pages devoted exclusively to providing important details about ECDIS. These pages are distinguished by the ECDIS icon, as shown in the top left corner of this page. The ECDIS pages are also listed in the table of contents in italic type.



One major difference in the use of paper charts and ENCs is the ability of ECDIS to display the same feature differently depending on user settings and other conditions, such as a ship's draft. An important example is that ECDIS displays wrecks, rocks and other obstructions with their traditional "paper chart" symbols if they are at or deeper than the depth of the safety contour set for the ship. Dangers that are shoaler are portrayed with the unique ECDIS "isolated danger" symbol shown at left. (See the ECDIS Portrayal of Depths page for more information about the ECDIS safety contour.)



Another advantage that ECDIS provides over paper charts is enabling users to obtain more information about a feature through a "cursor pick." Some feature attribute values that can be obtained by cursor pick are noted throughout U.S. Chart No. 1. This is especially true if a particular value, such as height, vertical clearance or the like is included in the INT symbol description. The cursor pick icon, shown at left, is used to indicate when a reference to a cursor pick is made.

There are many other attribute values that users may obtain through a cursor pick that are not specifically noted. These include, but are not limited to, the purpose, seasonality, periodicity, status, color, height, type of structure and the visual or radar conspicuousness of features; shape, color or color pattern of buoys; characteristics of lights; category of obstructions and wrecks; radar wave length, radio frequency, communication channel and call signs; the presence of AIS transmitted signals; information regarding pilotage services and many more.

U.S. Chart No. 1 is a handy guide for ECDIS users, but it is no substitute for mandated ECDIS training.

The ECDIS user and developer communities are invited to help improve the presentation of ECDIS symbology and information in U.S. Chart No. 1. Please let us know what additional information you would like to see in the next edition.

Corrections, comments, or questions regarding U.S. Chart No. 1 may be submitted through ASSIST, the NOAA Coast Survey stakeholder engagement and feedback website at www.nauticalcharts.noaa.gov/customerservice/assist,

or mailed to:

National Ocean Service, NOAA (N/CS2)
Attention: U.S. Chart No. 1
1315 East West Highway
Silver Spring, MD 20912-3282

SYMBOLS, ABBREVIATIONS AND TERMS

Contents

Document Sections and <i>ECDIS</i> Pages	Symbol Sections
Introduction	5
Schematic Layout	8
<i>Day, Dusk and Night Color Palettes</i>	9
<i>Conspicuous and Non-Conspicuous Features</i>	28
<i>ECDIS Portrayal of Depths</i>	47
<i>Examples of Routing Measures in ECDIS</i>	69
<i>Simplified and Traditional "Paper Chart" Symbols</i>	90
Index of Abbreviations	111
Index	117
Appendix 1, IALA Maritime Buoyage System	128
	GENERAL
	A Chart Number, Title, Marginal Notes
	B Positions, Distances, Directions, Compass
	TOPOGRAPHY
	C Natural Features
	D Cultural Features
	E Landmarks
	F Ports
	G (Not currently used)
	HYDROGRAPHY
	H Tides, Currents
	I Depths
	J Nature of the Seabed
	K Rocks, Wrecks, Obstructions, Aquaculture
	L Offshore Installations
	M Tracks, Routes
	N Areas, Limits
	O (Not currently used)
	NAVIGATION AIDS AND SERVICES
	P Lights
	Q Buoys, Beacons
	R Fog Signals
	S Radar, Radio, Satellite Navigation Systems
	T Services
	U Small Craft (Leisure) Facilities

INTRODUCTION

Two Symbology Types Comprising Four Symbology Sets

U.S. Chart No. 1 presents two types of symbology used for marine navigation – the symbols used on paper nautical charts (and their digital raster image equivalents) and the corresponding symbols used to portray Electronic Navigational Chart (ENC) data on Electronic Chart Display and Information Systems (ECDIS).

Within these two types, four separate symbology sets are shown. These are described below:

Paper Chart Symbols

INT — The international or “INT” symbols specified in the *Regulations for International (INT) Charts and Chart Specifications of the IHO* (International Hydrographic Organization). These symbols are used by many countries around the world, including the United States.

NOAA — Symbols used on charts produced by the National Oceanic and Atmospheric Administration (NOAA) when an INT symbol is not used. NOAA produces nautical charts for all U.S. waters, including the Great Lakes and U.S. Territories.

NGA — Symbols used on charts produced by the National Geospatial-Intelligence Agency (NGA) when an INT symbol is not used. NGA produces nautical charts for the U.S. military and for areas outside of U.S. waters.

ECDIS Symbols

ECDIS — Symbols used to portray ENCs on ECDIS navigation systems. Use of ECDIS is required for large commercial ships on international voyages. These symbols are specified in *IHO Specifications for Chart Content and Display Aspects of ECDIS*.

Other Non-ECDIS Digital Displays May Portray Data Differently

Navigation systems certified to meet the exacting performance standards established by the International Maritime Organization (IMO) are said to be ECDIS “type approved.” The symbology used to display ENCs or other non-ENC navigational data on non-ECDIS systems, such as geographic information systems, recreational GPS and other chart display systems can differ significantly from the symbology specified for ECDIS type approved systems. U.S. Chart No. 1 only shows the symbology used on ECDIS.

U.S. Chart No. 1 and Typical Chart Layouts

A brief description of the columns on each symbol description page is provided here. A detailed schematic layout of U.S. Chart No. 1 is on page 8. Section A, on pages 10 and 11 presents schematics showing typical layouts of the major elements of NOAA and NGA charts.

Col 1 — Symbol number. The number together with the section letter which appears at the top of each page constitutes a unique identifier for each symbol, such as C1 for the “Coastline, surveyed” symbol.

Col 2 — INT symbol example.

Col 3 — Description of the feature or real world phenomenon being portrayed.

Col 4 — NOAA symbol example. This column will be blank if NOAA uses the INT symbol shown in column 2.

Col 5 — NGA symbol example. This column will be blank if NGA uses the INT symbol shown in column 2.

If columns 4 and 5 are combined, then NOAA and NGA both use the same symbol, which is different from the INT symbol.

Col 6 — Other NGA symbol examples. NGA produces facsimiles of some foreign charts. If the depiction on the chart is different than the INT or NGA symbols (shown in Cols 2 and 5, respectively) then the additional foreign symbols are shown here.

Col 7 — ECDIS symbol example in the day color palettes.
(See page 9 for a description of ECDIS color palettes.)

Col 8 — The ECDIS description usually provides the generic symbol name given in the *IHO Specifications for Chart Content and Display Aspects of ECDIS*, although sometimes other clarifying terms are also provided.

The schematic layout on page 7 shows a typical symbol table page and provides more details about the table headers and the types of information presented in each of the columns.

INFORMATION ON SELECTED CHART FEATURES

Soundings

The sounding datum reference is stated in the chart title. Soundings on NOAA and NGA charts may be shown in fathoms, feet, fathoms and feet, fathoms and fractions, or meters and decimeters. In all cases the unit of depth used is shown in the chart title and outside the border of the chart in bold type (see item b in Section A). For ECDIS, the sounding datum is part of the ENC metadata, which can be retrieved through a cursor inquiry.

Heights

Heights of lights, landmarks, structures, etc. refer to the shoreline plane of reference. The unit of height is shown in the chart title. When the elevations of islets or bare rocks are offset into the adjacent water, they are shown in parentheses. For ECDIS, the unit of height is meters.

Drying Heights

For rocks and banks that cover and uncover, elevations are underlined and are referenced to the sounding datum as stated in the chart title (or in the ENC metadata). When the heights of rocks that cover and uncover are offset into the adjacent water, they are shown in parentheses.

Shoreline

Shoreline shown on charts represents the line of contact between the land and a selected water elevation. In areas affected by tidal fluctuation, this line of contact is usually the mean high water line. In confined coastal waters of diminished tidal influence, a mean water level may be used. The shoreline of interior waters (rivers, lakes) is usually a line representing a specified elevation above a selected datum. Shoreline is symbolized by a heavy line (symbol C 1). Apparent shoreline is used on charts to show the outer edge of marine vegetation where the limit would be expected to appear as the shoreline to the mariner or where it prevents the shoreline from being clearly defined. Apparent shoreline is symbolized by a light line (symbols C 32, C 33, C p, C q and C r).

Landmarks

A structure or a conspicuous feature on a structure may be shown by a landmark symbol with a descriptive label (see Section E). Prominent buildings that could assist the mariner may be shown by actual shape as viewed from above (see Sections D and E).

On NGA charts, landmark legends shown in capital letters indicate that a landmark is conspicuous; the landmark may also be labeled "CONSPICUOUS" or "CONSPIC." On NOAA charts, all landmarks are considered to be conspicuous, and landmark legends shown in all capital letters indicate a landmark has been positioned accurately; legends using both upper and lower case letters indicate an approximate position.

ECDIS portrays conspicuous features with black symbols and non-conspicuous features with brown symbols. Only the conspicuous version is shown in the lettered sections of U.S. Chart No. 1. See the ECDIS "Conspicuous and Non-Conspicuous Features" page in front of Section E for more information.

IALA Buoyage System

The International Association of Marine Aids to Navigation and Lighthouse Authorities (IALA) Maritime Buoyage System is followed by most of the world's maritime nations; however, systems used in some foreign waters may be different. IALA buoyage is divided into two regions: Region A and Region B. All navigable waters of the United States follow IALA Region B rules, except U.S. possessions west of the International Date Line and south of 10° north latitude, which follow IALA Region A rules.

The major difference between the two buoyage regions is the color of the lateral marks. Region A uses red to port and Region B uses red to starboard (red-right-returning). The shapes of the lateral marks are the same in both regions, can to port and cone (nun) to starboard, when entering from seaward. Cardinal and other marks, such as those for isolated dangers, safe water and special marks are also the same in both regions. Section Q and Appendix 1 illustrate the IALA buoyage system for both Regions A and B.

U.S. Lateral Marks

Most of U.S. waters are in IALA Region B. In the U.S. system, on entering a channel from seaward, buoys and beacon dayboards on the starboard side are red with even numbers and have red lights, if lit. Buoys and beacon dayboards on the port side are green with odd numbers and have green lights, if lit. Preferred channel buoys have red and green horizontal bands with the top band color indicating the preferred side of passage.

Light Range (Visibility)

A light's range or visibility is given in nautical miles, except on the Great Lakes and adjacent waterways, where light ranges are given in statute miles. For lights having more than one color, NOAA charts give only the shortest range of all the colors. On NGA charts, multiple ranges may be shown using the following convention. For lights with two colors, the first number indicates the range of the first color and the second number indicates the range of the second color. For example, FI WG 12/8M means the range of the white light is 12 nautical miles and the range of green light is 8 nautical miles. For lights with three colors, only the longest and shortest ranges are given and the middle range is indicated by a dash. For example, FI WRG 12-8M means that the range of the white light is 12 nautical miles, the range of green light is 8 nautical miles and the range of the red light is between 8 to 12 nautical miles. The dash can appear in any of the three positions.

Aids to Navigation Positioning

The fixed and floating aids to navigation depicted on charts have varying degrees of reliability. Floating aids are moored to sinkers by varying lengths of chain and may shift due to sea conditions and other causes. Buoys may also be carried away, capsized or sunk. Lighted buoys may be extinguished and sound signals may not function, because of ice or other causes. Therefore, prudent mariners will not rely solely on any single aid to navigation, particularly on floating aids, but will also use bearings from fixed objects and aids to navigation on shore.

Colors

Color conveys the nature and importance of features found on nautical charts. Chart elements significant to marine navigation, such as lights, compass roses and regulated areas, are emphasized with magenta. Lateral marks on NOAA charts are shown with a red or green fill. Shades of blue depict potential hazards to navigation, typically shallow water and submerged obstructions. Areas of deeper water believed to be clear of obstructions are shown as white. Land, and other features that are always dry, are depicted with buff on NOAA charts and gray on NGA charts. Foreshore and other intertidal features are portrayed with a green tint. Other colors may be used to provide additional information, such as protected areas, which are outlined in blue or green.

Traffic Separation Schemes

Traffic separation schemes show recommended lanes to increase safety of navigation, particularly in areas of high density shipping. These schemes are described in the International Maritime Organization (IMO) publication, *Ships Routeing*. Traffic separation schemes are generally shown on nautical charts at scales of 1:600,000 and larger. When possible, traffic separation schemes are plotted to scale and shown as depicted in Section M.

Conversion Scales

Depth conversion scales are provided on all charts to enable the user to work in meters, fathoms or feet.

Correction Date

The date of each new chart edition is shown below the lower left border of the chart. The date of the latest NGA issued U.S. Notice to Mariners applied to the chart is shown after the edition date. NOAA charts also show the date of the latest U.S. Coast Guard Local Notice to Mariners applied to the chart.

ADDITIONAL RESOURCES

Information on the use of nautical charts, aids to navigation, sounding datums and the practice of navigation in general is in *The American Practical Navigator* (Bowditch), available through the “Publications” link on the NGA Maritime Safety Information portal at <https://msi.nga.mil/NGAPortal/MSI.portal>.

Tide and current data over U.S. waters is available from the NOAA Center for Operational Oceanographic Products and Services at <https://tidesandcurrents.noaa.gov>.

Detailed information about specific lights, buoys, and beacons and general information about the U.S. Aids to Navigation System and the Uniform State Waterway Marking Systems is in the U.S. Coast Guard *Light List*, at <https://www.navcen.uscg.gov/?pageName=lightLists>.

Information about aids to navigation in foreign waters is in the NGA *List of Lights*, available through the “Publications” link on the NGA Maritime Safety Information portal at <https://msi.nga.mil/NGAPortal/MSI.portal>.

Other important information that cannot be shown conveniently on nautical charts can be found in the NOAA *U.S. Coast Pilot*[®], at <https://nauticalcharts.noaa.gov/publications/coast-pilot/index.html> and NGA *Sailing Directions*, available through the “Publications” link on the NGA Maritime Safety Information portal at <https://msi.nga.mil/NGAPortal/MSI.portal>.

U.S. Nautical Chart Catalogs and Indexes

NGA catalogs are available through the “Product Catalog” link on the NGA Maritime Safety Information portal at <https://msi.nga.mil/NGAPortal/MSI.portal>.

NOAA catalogs are available at the NOAA Chart Locator at www.charts.noaa.gov/InteractiveCatalog/nrnc.shtm and the NOAA Nautical Chart Catalog and Chart Viewer at www.charts.noaa.gov/ChartCatalog/MapSelect.html.

A list of the dates of the latest editions of NOAA charts is at <https://nauticalcharts.noaa.gov/charts/list-of-latest-editions.html>.

CORRECTIONS AND COMMENTS

Corrections to U.S. Chart No. 1 will appear in the weekly U.S. Notice to Mariners, available through the “Notice to Mariners” link on the NGA Maritime Safety Information portal at <https://msi.nga.mil/NGAPortal/MSI.portal>.

Corrections, comments, or questions regarding U.S. Chart No. 1 may be submitted through ASSIST, the NOAA Coast Survey stakeholder engagement and feedback website at www.nauticalcharts.noaa.gov/customer-service/assist.







or to:

National Ocean Service, NOAA (N/CS2)
Attention: U.S. Chart No. 1
1315 East West Highway
Silver Spring, MD 20910-3282

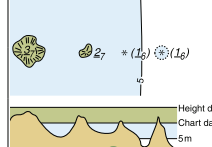
Schematic Layout of U.S. Chart No. 1:

(A) K Rocks, Wrecks, Obstructions (B)

(D) Supplementary national symbol: a

(C) Rocks							(D) Supplementary national symbol: a		
(E) Plane of Reference for Heights → H		Plane of Reference for Depths → H							
No.	INT	Description	NOAA	NGA	Other NGA	ECDIS			
11		Rock which covers and uncovers, height above chart datum				✖			rock which covers and uncovers or is awash at low water underwater hazard which covers and uncovers with drying height isolated danger of depth less than the safety contour
①	②	③	④a	④b	⑤	⑥	⑦		

(A)	Section designation
(B)	Section
(C)	Sub-section
(D)	Reference to "Supplementary national symbols" at the end of each section
(E)	Cross-reference to terms in other sections
①	Column 1: Numbering system following the "Chart Specification of the IHO". A letter in this column indicates a supplementary national symbol or abbreviation for which there is no international equivalent.
②	Column 2: Representation that follows the "Chart Specifications of the IHO" (INT 1 symbol)
③	Column 3: Description of symbol, term, or abbreviation
④a*	Column 4a: Representation used on charts produced by the National Oceanic and Atmospheric Administration (NOAA)
④b*	Column 4b: Representation used on charts produced by the National Geospatial-Intelligence Agency (NGA)
⑤	Column 5: Representation of symbols that may appear on NGA reproductions of foreign charts
⑥**	Column 6: Representation used to portray ENC data on ECDIS
⑦**	Column 7: Description of ECDIS symbols
*	When columns 4a and 4b are combined then NOAA and NGA both use the same symbol. When either column 4a or 4b is blank then the respective agency uses the INT 1 symbol shown in column 2.
**	When columns 6 and 7 have several rows for the same symbol number, then ECDIS portrays this feature differently depending on the ship's draft and other conditions as defined in ECDIS by the mariner (as is the case for K 11). When columns 6 and 7 combine rows to span across several symbol numbers then ECDIS portrays all of the grouped symbol numbers the same way (see C 5–C 7).
†	Signifies that this representation is obsolete, but it may appear on older charts.
✖	Signifies that a feature attribute value, such as a height, distance or name, may be obtained through an ECDIS cursor pick report. There are many attribute values that may be obtained in this manner, but the cursor pick icon is only used to note values that are specifically referred to in the description of symbols column and that ECDIS does not display next to the symbol. Height of trees in C 14 is an example.

Day, Dusk and Night Color Palettes



ECDIS allows the mariner to change the color palette that is used to display an ENC. Three different color tables have been designed to provide the maximum clarity and contrast between features on the display under three different lighting conditions on the bridge, namely Day, Dusk and Night.

Each symbol is rendered in a different color appropriate for the lighting condition that the color table is meant for. This design provides maximum contrast for the display on a sunny day, as well as preserving night vision on a dimly lit bridge in the evening. This allows the mariner to look back and forth between the chart on the ECDIS display and out to sea through the bridge window without the mariner's eyes needing to readjust to a difference in light intensity.

- The Day Color Table, meant to be used in bright sunlight, uses a white background for deep water and looks the most like a traditional paper chart.
- The Dusk Color Table uses a black background for deep water and colors are subdued, but slightly brighter than those used in the Night Color Table.
- The Night Color Table, meant to be used in the darkest conditions, uses a black background for deep water and muted color shades for other features.

The images on the right show each of the three color palettes.

The symbols shown in the remainder of this document use the day color palette.

DAY



DUSK



NIGHT



A Chart Number, Title, Marginal Notes

Schematic Layout of a NOAA Chart (reduced in size)

Note: this is an example only and not to be used for navigation

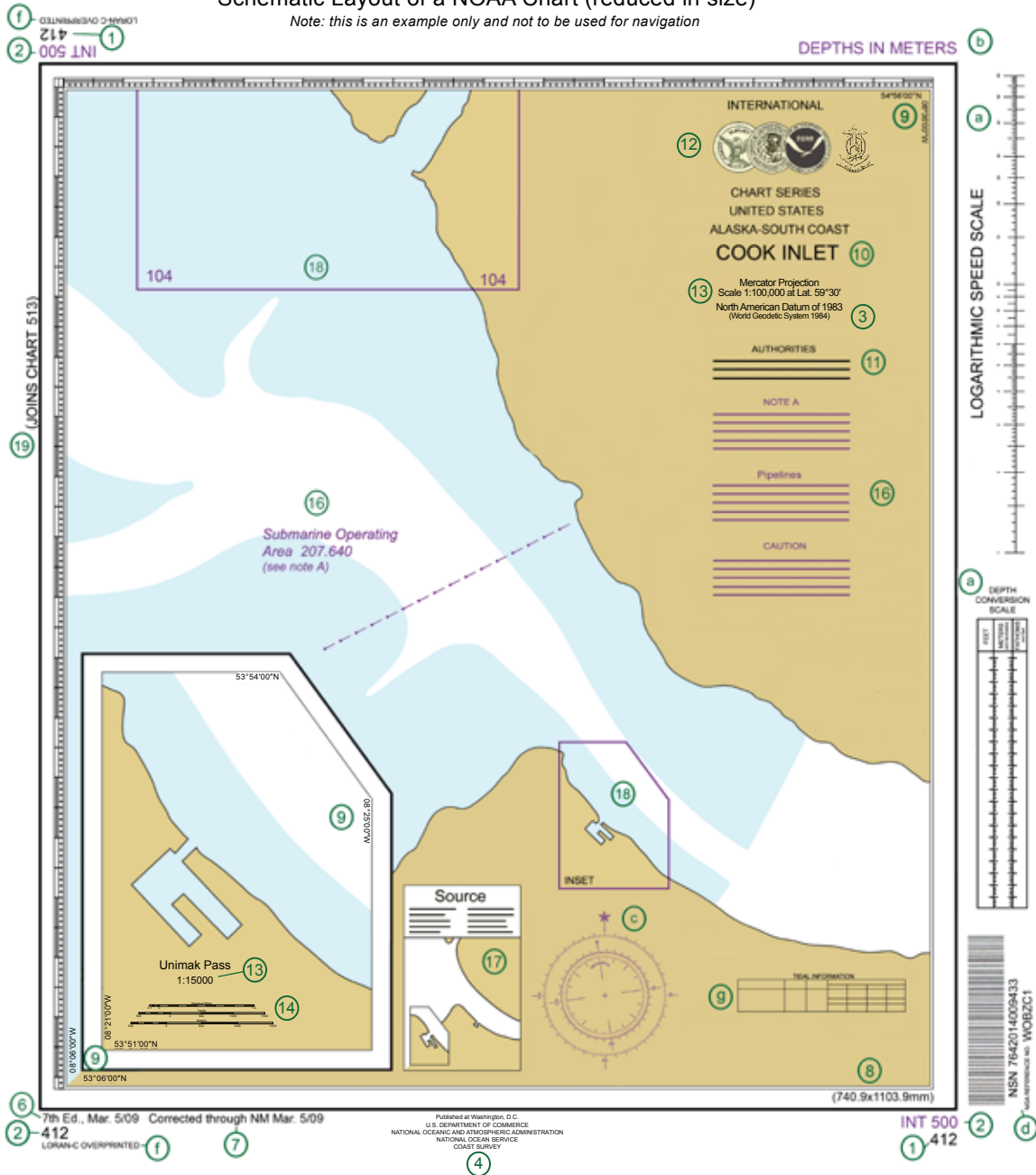

Magnetic Features → B	
Tidal Data → H	
①	Chart number in national chart series
②	Chart number in international (INT) series (if any)
③	Reference ellipsoid of the chart
④	Publication note (imprint)
⑤	Copyright note
⑥	Date of current edition
⑦	Notice to Mariners corrections
⑧	Dimensions of inner borders
⑨	Corner coordinates
⑩	Chart title
⑪	Explanatory notes on chart construction, etc. To be read before using chart.
⑫	Seal(s)
⑬	Scale of chart. Some charts have scale at a stated latitude.
⑭	Linear scale on large scale charts

Schematic Layout of an NGA Chart (reduced in size)

Note: this is an example only and not to be used for navigation



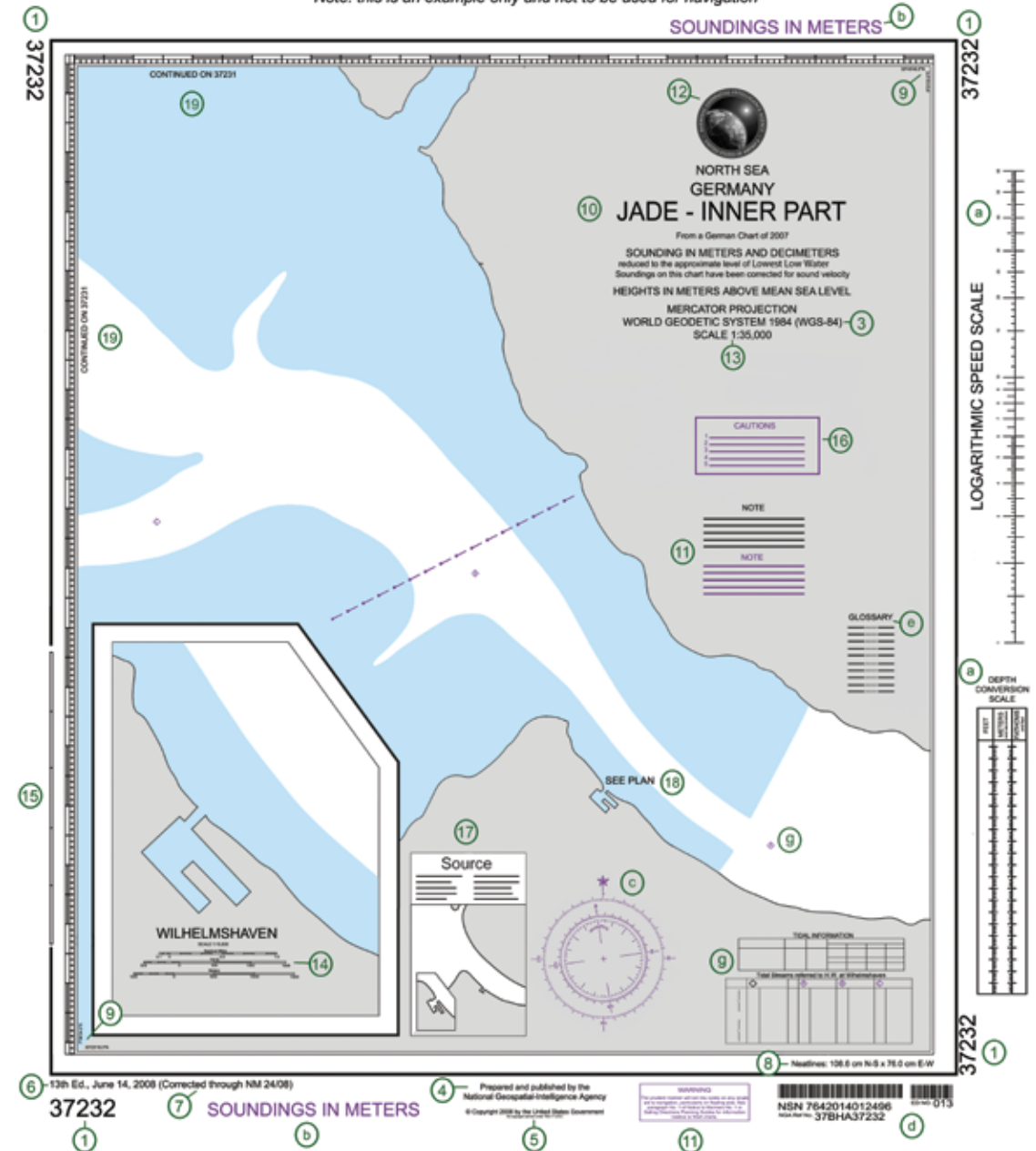









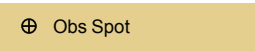

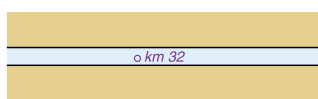
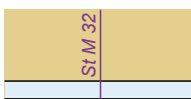
15	Linear border scale on large scale charts. On smaller scales use latitude borders for sea miles.
16	Cautionary notes (if any). Information on particular features, to be read before using chart.
17	Source Diagram (if any). Navigators should be cautious where surveys are inadequate.
18	Reference to a larger scale chart
19	Reference to an adjoining chart of similar scale
a	Conversion scales
b	Reference to the units used for depth measurement
c	Compass rose
d	Bar code and stock number
e	Glossary: Translation of words on chart that are not in English
g	Tidal and Tidal Stream information within the chart coverage

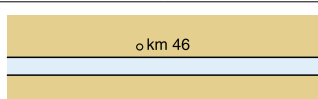
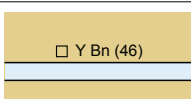
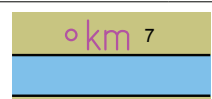
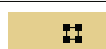
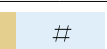
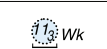

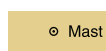
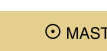

B Positions, Distances, Directions, Compass

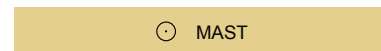

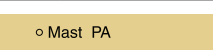
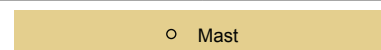

No.	INT	Description	NOAA	NGA	Other NGA	ECDIS
Geographical Positions						
1	Lat	Latitude				
2	Long	Longitude				
4		Degree(s)		deg		
5		Minute(s) of arc				
6		Second(s) of arc				
7	PA	Position approximate (not accurately determined or does not remain fixed)	PA	(PA)		PA Position approximate
						? Point feature or area of low accuracy
						(21) Sounding of low accuracy
8	PD	Position doubtful (reported in various positions)	PD	(PD)		? Point feature or area of low accuracy
						(21) Sounding of low accuracy
9	N	North				
10	E	East				
11	S	South				
12	W	West				
13	NE	Northeast				
14	SE	Southeast				
15	NW	Northwest				
16	SW	Southwest				

Positions, Distances, Directions, Compass B

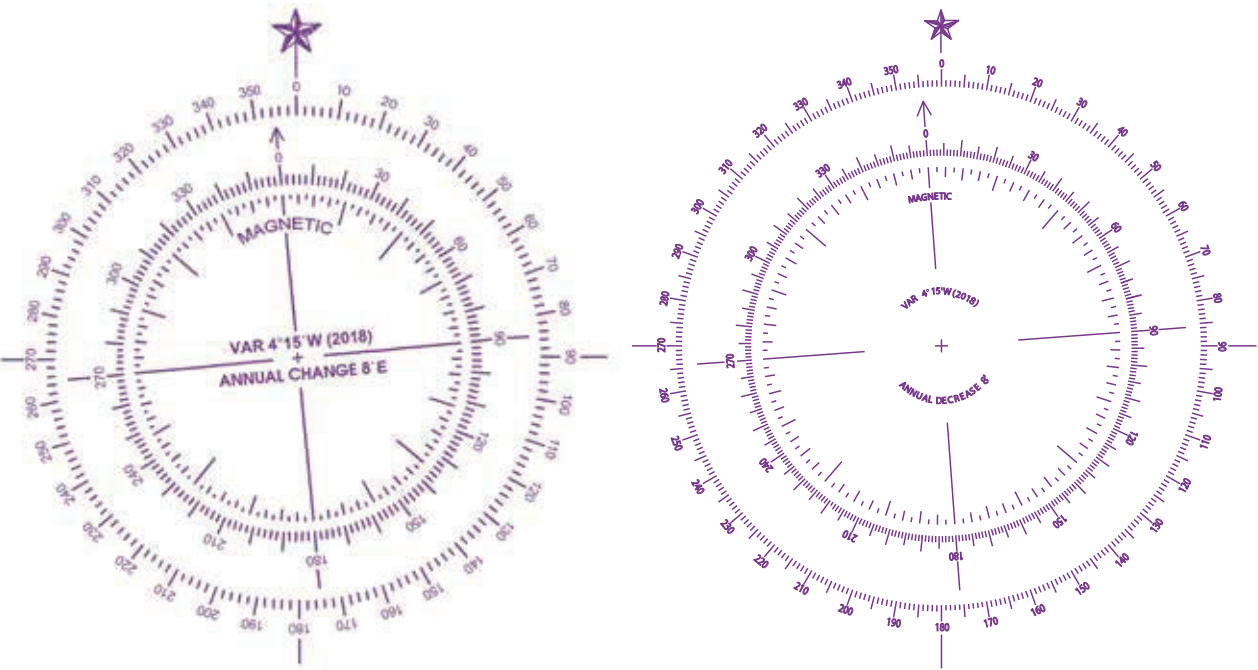

No.	INT	Description	NOAA	NGA	Other NGA	ECDIS	
Control Points							
20		Triangulation Point				 Position of an elevation or control point	
21		Observation spot		Obs Spot			
22		Fixed point					
25.1		Distance along waterway, no visible marker					Canal and distance point with no mark
25.2		Distance along waterway with visible marker					Canal and distance point
Note: ECDIS uses a magenta “km” symbol to represent distance marks. However, the distances shown along waterways on NOAA-produced ENC’s are displayed in statute miles.							
Symbolized Positions (Examples)							
30	  	Symbols in plan—position is center of primary symbol				ECDIS follows the paper chart convention for the position of symbols, except for simplified symbols for buoys and beacons (see Q 1).	
31	   	Symbols in plan—position is at bottom of symbol					
32	  	Point symbols		MAST		 Position of a point feature	
33	 	Point symbols—approximate positions		Mast		ECDIS indicates approximate position only for wrecks, obstructions, islets and shoreline features.	
Units						Supplementary national symbols <i>a–m</i>	
40	km	Kilometer(s)					
41	m	Meter(s)					
42	dm	Decimeter(s)					
43	cm	Centimeter(s)					
44	mm	Millimeter(s)					
45	M	International nautical mile(s) (1852m), sea mile(s)	Mi NMi NM				
47	ft	Foot / Feet					
48	fm, fms	Fathom(s)					

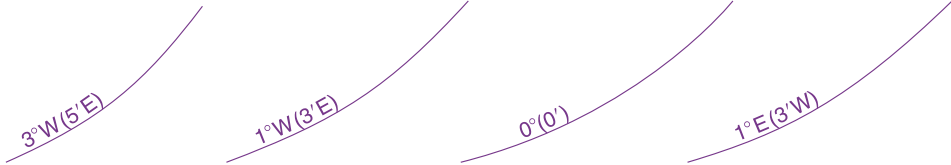
B Positions, Distances, Directions, Compass

No.	INT	Description	NOAA	NGA	Other NGA	ECDIS
49	h	Hour(s)	hr			
50	m	min	Minute(s) of time			
51	s	sec	Second(s) of time			
52	kn	Knot(s)				
53	t	Ton(s), Tonnage (weight)				
54	cd	Candela(s)				
Magnetic Compass						Supplementary national symbols <i>n</i>
68.1	<div style="border: 1px solid purple; padding: 2px; display: inline-block;"> Magnetic Variation 4°30' W 2011 (8°E) </div>	Note of magnetic variation, in position				 Cursor pick site for magnetic variation at a point
						 Cursor pick site for magnetic variation over an area
68.2	Magnetic Variation at 55°N 8°W 4°30' W 2011 (8°E)	Note of magnetic variation, out of position				

No.	NOAA / NGA	ECDIS
70	<p>Compass rose, normal pattern (smaller patterns of compass rose may be used)</p> <p>Magnetic variation (example): VAR 4°15'W (2018) means magnetic variation was 4°15'W in 2018 ANNUAL DECREASE 8' means annual change is 8'E or decreasing 8' annually For 2019 the magnetic variation is 4°7'W</p> 	 <p>Cursor pick site for magnetic variation at a point</p>
71	<p>Isogonic lines, Isogonals</p> <p>MAGNETIC VARIATION LINES ARE FOR 2018</p> <p>The magnetic variation is shown in degrees, followed by the letter W or E, as appropriate, at certain positions on the lines. The annual change is expressed in minutes with the letter W or E and is given in brackets, immediately following the variation.</p> 	 <p>Cursor pick site for magnetic variation along a line</p>

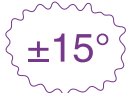









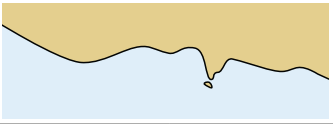
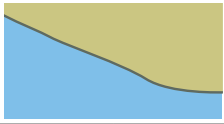
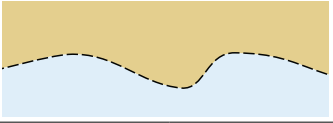
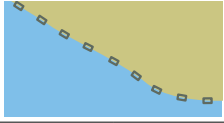
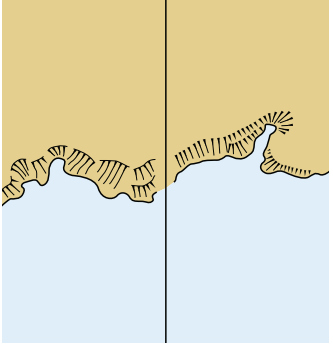



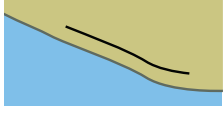

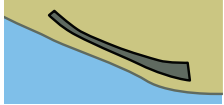

B Positions, Distances, Directions, Compass

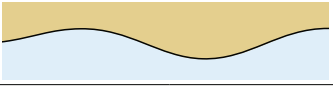
No.	INT	Description	NOAA	NGA	Other NGA	ECDIS	
82.1		Local magnetic anomaly Within the enclosed area the magnetic variation may deviate from the normal by the value shown					Cursor pick site for magnetic anomaly along a line or over an area
82.2	Local Magnetic Anomaly (see Note)	Local magnetic anomaly Where the area affected cannot be easily defined, a legend only is shown at the position	LOCAL MAGNETIC DISTURBANCE (see note)	LOCAL MAGNETIC ANOMALY (see note)	LOCAL MAGNETIC DISTURBANCE (see note)		Cursor pick site for magnetic anomaly at a point
Supplementary National Symbols							
a		Square meter(s)	m ²				
b		Cubic meter(s)	m ³				
c		Inch(es)	in				
d		Yard(s)	yd				
e		Statute mile(s)	St M	St Mi			
f		Microsecond(s)	μsec	μs			
g		Hertz	Hz				
h		Kilohertz	kHz				
i		Megahertz	MHz				
j		Cycles/second	cps	c/s			
k		Kilocycle(s)	kc				
l		Megacycle(s)	Mc				
m		Ton(s) (U.S. short ton) (2,000lbs)	T				
o		Benchmark	BM				
p		Variation	var	VAR		Varn	Magnetic variation

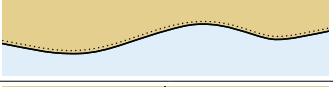
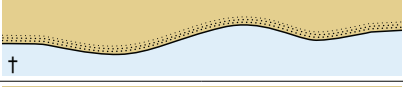
Positions, Distances, Directions, Compass **B**



No.	INT	Description	NOAA	NGA	Other NGA	ECDIS
q		Magnetic		mag		
r		Bearing		brg		
s		True		T		







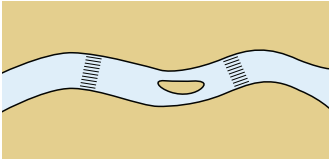
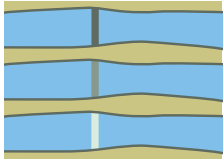
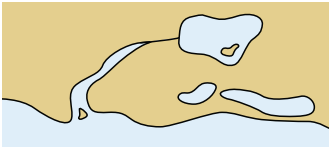
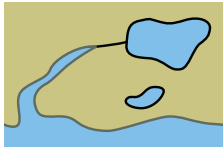
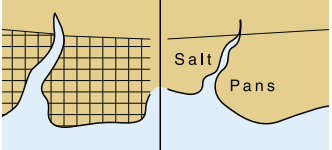
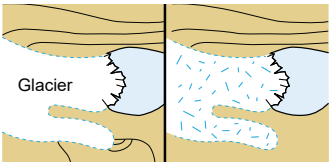
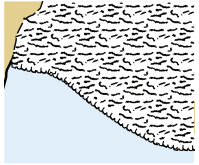

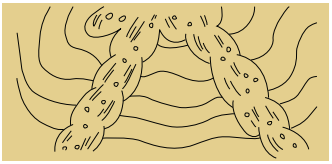
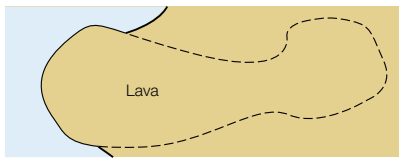
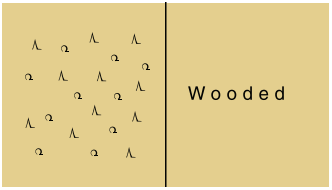
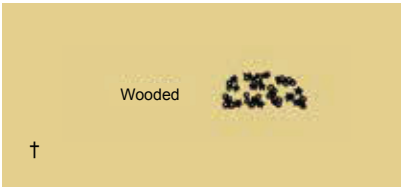
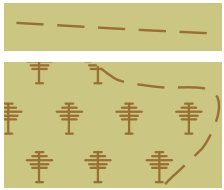







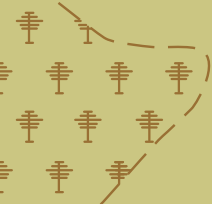

C Natural Features

No.	INT	Description	NOAA	NGA	Other NGA	ECDIS	
Coastline						Supplementary national symbols: a–e	
Foreshore → I, J							
1		Coastline, surveyed					Coastline
2		Coastline, unsurveyed					Coastline or shoreline construction of low accuracy in position
3		Cliffs, Steep coast					Presence of cliffs coincident with coastline is obtained by cursor pick
							Sloping ground crest line distant from coastline, radar or visually conspicuous
							Cliff as an area
4		Hillocks					Conspicuous hill or mountain top
5		Flat coast					
6		Sandy shore					Nature of coastline is obtained by cursor pick
7		Stony shore, Shingly shore					
8		Sandhills, Dunes					Conspicuous hill or mountain top





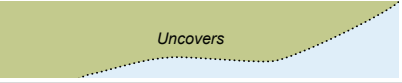

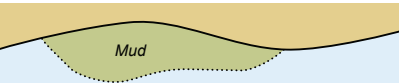
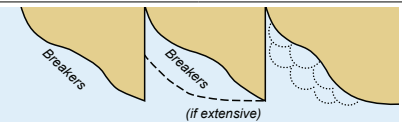



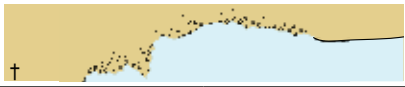

No.	INT	Description	NOAA	NGA	Other NGA	ECDIS
Relief						
Supplementary national symbols: e–g						
Plane of reference for heights → H						
10		Contour lines with values and spot height				
11		Spot heights				
12		Approximate contour lines with values and approximate height				
13		Form lines with spot height				
14		Approximate height of top of trees (above height datum)				
Water Features, Lava						
20		River, Stream				
21		Intermittent river, intermittent lake				

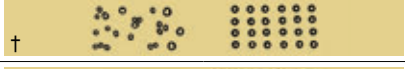
C Natural Features

No.	INT	Description	NOAA	NGA	Other NGA	ECDIS	
22		Rapids, Waterfalls				 <p>Rapids</p> <p>Waterfall</p> <p>Waterfall, visually conspicuous</p>	
23		Lakes				 <p>Lake</p>	
24		Salt pans					
25		Glacier				 <p>Continuous pattern for an ice area (glacier, etc.)</p>	
26		Lava flow					
Vegetation						Supplementary national symbols: i-t	
30		Woods in general				 <p>Line of trees</p> <p>Wooded area</p>	

No.	INT	Description	NOAA	NGA	Other NGA	ECDIS
31	Prominent trees (isolated or in groups)					
31.1		Unspecified tree				 Tree
31.2		Evergreen (except conifer)				
31.3		Conifer, Casuarina				 Vegetation, line of trees
31.4		Palm				
31.5		Nipa Palm				 Wooded area
31.6		Casuarina				
31.7		Filao				
31.8		Eucalypt				
32		Mangrove, Nipa palm				 Mangrove with coastline or shoreline construction of low accuracy in position
33		Marsh, Swamp, Reed beds	 <i>(used in small areas)</i>			 Marsh with coastline or shoreline construction of low accuracy in position
Supplementary National Symbols						
a		Chart sounding datum line surveyed)				
b		Approximate sounding datum line (inadequately surveyed)				
c		Foreshore; Strand (in general); Stones; Shingle; Gravel; Mud; Sand				
d		Breakers along a shore				

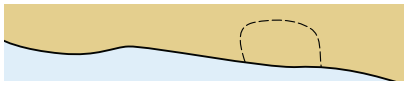
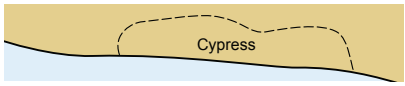
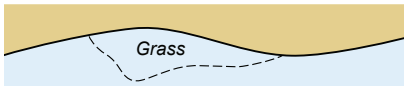
C Natural Features

No.	INT	Description	NOAA	NGA	Other NGA	ECDIS
e		Rubble				
f		Hachures				
g		Shading				
i		Deciduous woodland				
j		Coniferous woodland				
k		Tree plantation				
l		Cultivated fields				
m		Grassfields				
n		Paddy (rice) fields				
o		Bushes				
p		Apparent shoreline				
q		Vegetation or topographic (Feature Area Limit-in general)				
r		Cypress				
s		Grass				
t		Eelgrass				







No.	INT	Description	NOAA	NGA	Other NGA	ECDIS
Settlements, Buildings						
Height of objects → E		Landmarks → E				
1		Urban area				Built-up area
2		Settlement with scattered buildings				
3		Settlement (on medium and small scale charts)				Built-up area as a point
4		Village				
5		Buildings				Conspicuous single building
6		Important building in built-up area				Conspicuous single building in built-up area
7		Street name, Road name				Street name is obtained by cursor pick
8		Ruin, Ruined landmark				Status of ruins is obtained by cursor pick
Roads, Railways, Airfields			Supplementary National Symbols: a–c			
10		Motorway, highway				Road, track or path as a line
11		Road (hard surfaced)				
12		Track, Path (loose or unsurfaced)				Road as an area

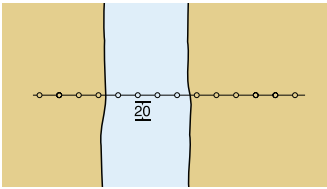

D Cultural Features

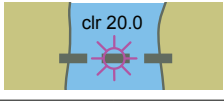
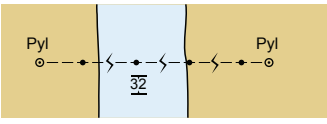
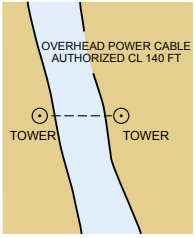
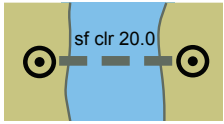
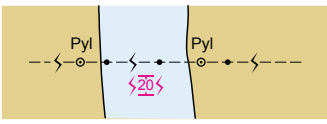
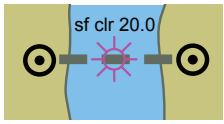
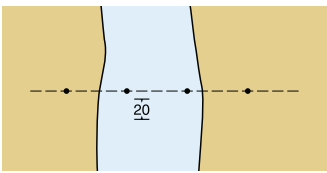
No.	INT	Description	NOAA	NGA	Other NGA	ECDIS	
13		Railway, with station					Railway, with station
14		Cutting					Cutting
15		Embankment					Embankment
							Embankment, visually or radar conspicuous
16		Tunnel					Tunnel
							Tunnel with depth below the seabed encoded
17		Airport, Airfield					Airport as a point
							Runway as a line
							Airport area, with runway area and visually conspicuous runway area
18		Heliport, Helipad					
Other Cultural Features						Supplementary National Symbols: d-i	
20.1		Fixed bridge					
20.2		Footbridge, fixed bridge on smaller scale charts					

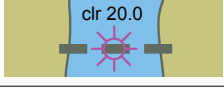
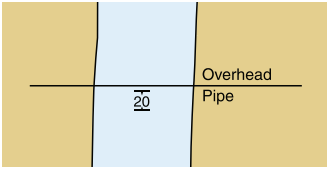
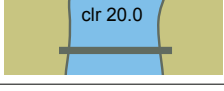
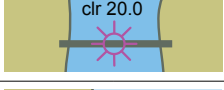
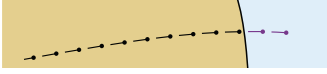
No.	INT	Description	NOAA	NGA	Other NGA	ECDIS	
21		Horizontal clearance	FIXED BRIDGE HOR CL 25 FT VERT CL 20 FT	HOR CL 8 M —8—		Horizontal clearance is obtained by cursor pick	
22		Vertical clearance (see introduction)		VERT CL 6 M 6 			Bridge
23.1		Opening bridge (in general) with vertical clearance					Opening bridge
23.2		Swing bridge with vertical clearance					
23.3		Lifting bridge with vertical clearance (closed and open)					
23.4		Bascule bridge with vertical clearance					
23.5		Pontoon bridge					Bridge
23.6		Draw bridge with vertical clearance					Opening bridge
24		Transporter bridge with vertical clearance below fixed structure					Bridge

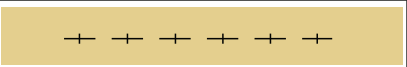

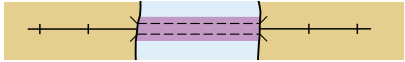
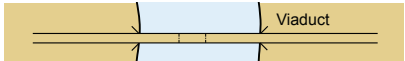
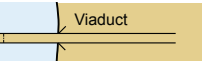

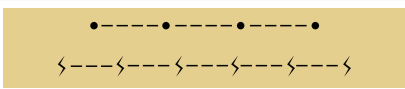
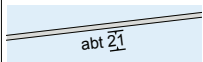



























D Cultural Features

















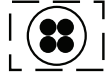

No.	INT	Description	NOAA	NGA	Other NGA	ECDIS	
25		Overhead transporter, Aerial cableway with vertical clearance					Aerial cableway
							Aerial cableway, radar conspicuous
26.1		Overhead power cable with pylons and physical vertical clearance					Transmission line
26.2		Overhead power cable with pylons and safe vertical clearance					
Note D26.2: The safe vertical clearance defined by the responsible authority, to avoid risk of electrical discharge, has been obtained by applying a reduction to the physical vertical clearance of the cable. The reduction is variable and depends upon the transmission voltage. See H20.							
27		Overhead cable, Telephone line, with vertical clearance					Overhead cable
							Overhead cable, radar conspicuous
28		Overhead pipe with vertical clearance					Overhead pipeline
							Overhead pipeline, radar conspicuous
29		Pipeline on land					Oil, gas pipeline, submerged or on land
Supplementary National Symbols							
a		Highway markers					
c		Abandoned railroad					

No.	INT	Description	NOAA	NGA	Other NGA	ECDIS
d		Bridge under construction				
f		Viaduct				
g		Fence				
h		Power transmission line				
i		Approximate vertical clearance				







Conspicuous and Non-conspicuous Features





























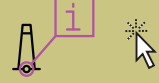

















There are 25 features for which ECDIS displays either a black symbol, if the feature is visually conspicuous, or a brown symbol if it is not. Only conspicuous landmarks are depicted on NOAA paper charts and ENC's. Therefore, only the conspicuous symbol versions are shown in the symbol tables of U.S. Chart No. 1. Both versions of the symbols for these features are shown on this page.

Cairn		
Chimney		
Dish aerial		
Dome		
Flare stack		
Fortified structure		
Hill or mountain top		
Mast		
Monument		
Mosque or minaret		
Position of a point feature		
Radar scanner		
Radio, television tower		
Refinery		
Religious building, Christian		
Religious building, non-Christian		

Silo		
Single building		
Tank		
Tank farm		
Tower		
Water tower		
Windmill		
Windmotor		
Wind generator farm		























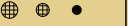



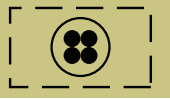



















The seven symbols shown below represent features that only have a brown symbol. There is no corresponding black, conspicuous symbol. The brown symbol is displayed regardless of the conspicuousness of the feature.

Cranes	
Flagstaff, flagpole	
Mangrove	
Mine, quarry	
Quarry	
Timber yard	
Tree	











No.	INT	Description	NOAA	NGA	Other NGA	ECDIS	
Plane of Reference for Height → H		Lighthouses → P		Beacons → Q			
General							
1	 Factory  Hotel	Examples of landmarks	 TANK  Tr  MONUMENT			  	Non-conspicuous point feature Non-conspicuous building Non-conspicuous water tower
2	 FACTORY  HOTEL  WATER TR	Examples of conspicuous landmarks (On NOAA charts, a large circle with dot and capitals indicates that position is accurate; a small circle with lowercase indicates that position is approximate.)	 EMPIRE STATE BUILDING  SPIRE  RADAR MAST  CHIMNEY			  	Conspicuous point feature Conspicuous building Conspicuous water tower
3.1		Pictorial sketches in true position)					The information symbol is displayed if a supplemental image is available, which may be accessed by cursor pick
3.2		Pictorial sketches out of position)					
4	 (30)	Height of top of a structure above height datum					Height is obtained by cursor pick
5	 (30)	Height of structure above ground level					
Landmarks							
10.1	  Ch	Church			 		Church as a point
							Church as an area
10.2	 Tr	 Tr	Church tower				Church tower, spire, or dome
10.3	 Sp	 Sp	Church spire	 SPIRE  Spire			
10.4	 Cup	 Cup	Church cupola (dome)	 CUPOLA  Cup			
13		Temple, Pagoda, Shrine, Marabout, Joss house					Religious building, non-Christian

E Landmarks

No.	INT	Description	NOAA	NGA	Other NGA	ECDIS
17		Mosque, Minaret				Mosque or minaret
19		Cemetery				Landmark area, type is obtained by cursor pick
20	Tr	Tower	Tr			Tower
21		Water tower, Water tank on a tower	S'pipe Wtr Tr			Water tower
22	Chy	Chimney	Chy			Chimney
23		Flare stack (on land)	Flare			Flare stack
24	Mon	Monument (including column, pillar, obelisk, statue, calvary cross)	Mon			Monument
25.1		Windmill	Windmill			Windmill, status of ruins is obtained by cursor pick
25.2	Ru	Windmill (without sails)				
26.1	† ‡	Wind turbine, Windmotor	Windmotor			Wind motor
26.2		Onshore wind farm	Wind Farm			Wind generator farm
27	FS	Flagstaff, Flagpole	FS FP	FS FP		Flagstaff, flagpole
28		Radio mast, Television mast	R Mast TV Mast	R Mast TV Mast		Mast
29		Radio tower, Television tower	R Tr TV Tr	R Tr TV Tr		Radio, television tower
30.1	Radar	Radar mast	Radar Mast	Radar Mast		Mast
30.2	Radar	Radar tower	Radar Tr	Radar Tr		Radar tower











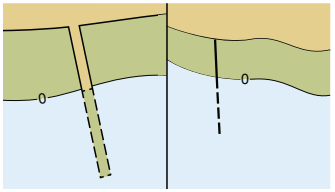





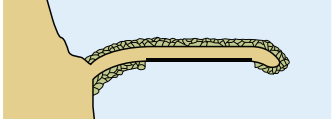
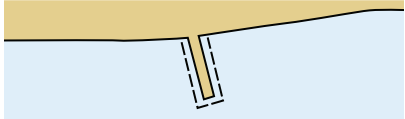

No.	INT	Description	NOAA	NGA	Other NGA	ECDIS	
30.3		Radar scanner					Radar scanner
30.4		Radome	 	 			Dome
31		Dish aerial	 				Dish aerial
32	 T a n k s	Tanks	  				Tank
							Tank farm
33	 S i l o	Silo	   				Silo
34.1		Fortified structure (on large scale charts)					Fortified structure
34.2		Castle, Fort, Blockhouse (on small scale charts)					Fortified structure
34.3		Battery, Small fort (on small scale charts)					
35.1		Quarry (on large scale charts)					Quarry area
35.2		Quarry (on small scale charts)					Quarry
36		Mine					
37.1		Recreational vehicle site					
37.2		Camping site (including recreational vehicles)					
Supplementary National Symbols							
a		Muslim shrine	 				
b		Tomb	 				
c		Watermill	 				

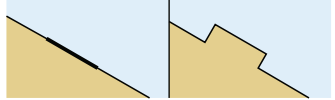
E Landmarks

No.	INT	Description	NOAA	NGA	Other NGA	ECDIS
d		Factory		 Facty		
e		Well	 Well			
f		School	 Sch	 Sch		
g		Hospital	 Hosp			
h		University	 Univ	 Univ		
i		Gable	 GAB  Gab			
k		Telegraph Telegraph office	Tel Tel Off			
l		Magazine	Magz			
m		Government house	Govt Ho			
n		Institute	Inst			
o		Courthouse	Ct Ho			
p		Pavilion	Pav			
q		Telephone	T			
r		Limited	Ltd			
s		Apartment	Apt			
t		Capitol	Cap			
u		Company	Co			
v		Corporation	Corp			

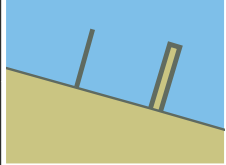
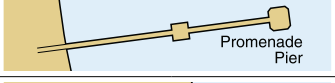
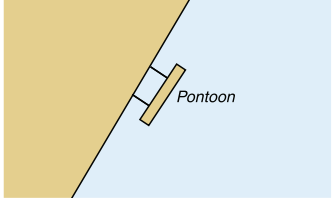
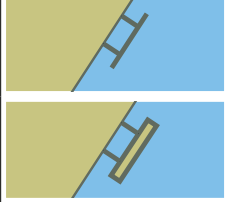

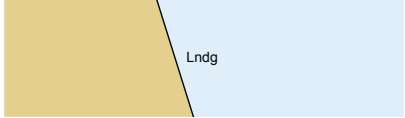







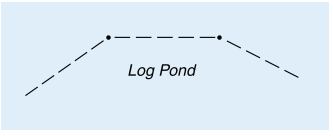

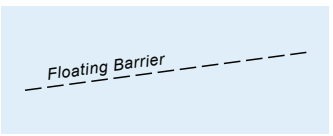
No.	INT	Description	NOAA	NGA	Other NGA	ECDIS
Protective Structures						Supplementary national symbols: a-c
1		Dike, Levee, Berm				<p>Dike as a line</p> <p>Dike as a line, conspicuous</p> <p>Dike as an area</p>
2.1		Seawall (on large scale charts)				Seawall
2.2		Seawall (on small scale charts)				
3		Causeway				<p>Causeway as a line</p> <p>Causeway, covers and uncovers as a line</p> <p>Causeway as an area</p> <p>Causeway, covers and uncovers as an area</p>
4.1		Breakwater (in general)				Breakwater as a line
4.2		Breakwater (loose boulders, tetrapods, etc.)				Breakwater as an area
4.3		Breakwater (slope of concrete or masonry)				
5		Training wall (partly submerged at high water)				Training wall

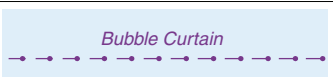
F Ports

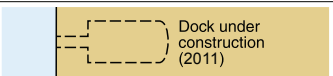
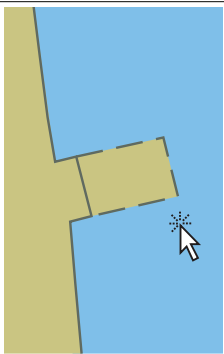
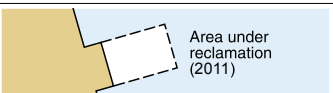
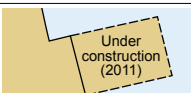
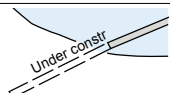
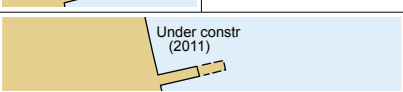
No.	INT	Description	NOAA	NGA	Other NGA	ECDIS
6		Groin (partly submerged at high water)				 Groin (intertidal)
Harbor Installations						
Depths → I		Anchorages, Limits → N		Beacons and other fixed marks → Q		Marina → U
10		Fishing harbor				 Fishing harbor
11.1		Boat harbor, Marina				 Yacht harbor, marina
11.2		Yacht berths without facilities				
11.3		Yacht club, Sailing club				
12		Mole (with berthing facility)				 Mole as a line Mole as an area
13		Quay, Wharf	 Whf			 Wharf (quay)
14		Pier, Jetty	 Pier			 Pier (jetty), promenade pier
15		Promenade pier				
16		Pontoon				 Pontoon as a line Pontoon as an area
17		Landing for boats	 Lndg			 Landing

No.	INT	Description	NOAA	NGA	Other NGA	ECDIS
18		Steps, Landing stairs				
19.1		Designation of berth	3	A	3	
19.2		Visitors' berth				
19.3		Dangerous cargo berth				
20		Dolphin				
21		Deviation dolphin				
22		Minor post or pile				
23		Slipway, Patent slip, Ramp				
24		Gridiron, Scrubbing grid, Careening grid				
25		Dry dock, Graving dock				
26		Floating dock				
27		Non-tidal basin, Wet dock				

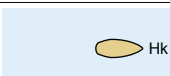
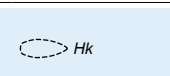
F Ports

No.	INT	Description	NOAA	NGA	Other NGA	ECDIS	
28		Tidal basin, Tidal harbor				 Dock	
						 Dock, under construction or ruined	
29.1		Floating barrier, e.g. security, containment booms (ice, logs, oil), shark nets: - with supports - without supports				 Floating hazard	
						 Boom Floating oil barrier, oil retention (high pressure pipe)	
29.2		Bubble curtain (bubbler, pneumatic pipe)				 Boom, floating obstruction	
30		Works on land, with year date					
31		Works at sea, Area under reclamation, with year date					Ruin or works under construction
32	Under construction (2011) Works in progress (2011)	Works under construction, with year date					Year and condition of under construction or ruin is obtained by cursor pick
33.1		Ruin					
33.2		Ruined pier, partly submerged at high water					 Pier, ruined and partly submerged
34		Hulk					 Hulk
							

No.	INT	Description	NOAA	NGA	Other NGA	ECDIS
Canals, Barrages						Supplementary national symbol: d
Cultural Features → B		Clearances → D	Signal Stations → T			
40		Canal				
41.1		Lock (on large scale charts)				
41.2		Lock (on small scale charts)				
42		Gate, Caisson				
43		Flood barrage				
44		Dam, Weir (direction of flow shown is left to right)				

F Ports

No.	INT	Description	NOAA	NGA	Other NGA	ECDIS
Transshipment Facilities						Supplementary national symbols: e-f
	Roads → D	Railways → D	Tanks → E			
50		Roll-on, Roll-off Ferry Terminal (RoRo Terminal)				RoRo RoRo terminal
51		Transit shed, Warehouse (with designation)				 Conspicuous single building, designation is obtained by cursor pick
52		Timber yard				# Timber yard as a point # Timber yard as an area
53.1		Crane with lifting capacity, Traveling crane (on railway)				 Lifting capacity is obtained by cursor pick T Crane as a point
53.2		Container crane (with lifting capacity)				 Crane as an area Crane, visually conspicuous as an area
Public Buildings						Supplementary national symbol: g
60		Harbormaster's office				 Conspicuous single building
61		Custom office				 Conspicuous single building Customs
62.1		Health office, Quarantine building				 Conspicuous single building
62.2		Hospital				
63		Post office				

No.	INT	Description	NOAA	NGA	Other NGA	ECDIS
Supplementary National Symbols						
a		Jetty (partly below MHW)				
b		Submerged jetty				
c		Jetty (on small scale charts)				
d		Pump-out facilities				
e		Quarantine office				
g		Conveyor				

H Tides, Currents

Terms Relating to Tide Levels

INT Terms		
No.	Term	Description
1	CD	Chart Datum, Datum for sounding reduction
2	LAT	Lowest Astronomical Tide
3	HAT	Highest Astronomical Tide
4	MLW	Mean Low Water
5	MHW	Mean High Water
6	MSL	Mean Sea Level
8	MLWS	Mean Low Water Springs
9	MHWS	Mean High Water Springs
10	MLWN	Mean Low Water Neaps
11	MHWN	Mean High Water Neaps
12	MLLW	Mean Lower Low Water
13	MHHW	Mean Higher High Water
14	MHLW	Mean Higher Low Water
15	MLHW	Mean Lower High Water
16	Sp	Spring tide
17	Np	Neap tide

Supplementary National Terms (see I-t for other terms and symbols)		
No.	Term	Description
a	HW	High Water
b	HHW	Higher High Water
c	LW	Low Water
d	LWD	Low Water Datum
e	LLW	Lower Low Water
f	MTL	Mean Tide Level
g	ISLW	Indian Spring Low Water
h	HWF&C	High Water Full and Change (Vulgar establishment of the port)
i	LWF&C	Low Water Full and Change
j	CRD	Columbia River Datum
k	GCLWD	Gulf Coast Low Water Datum

No. _____

Tidal Levels and Charted Data

Tide Gauge → T

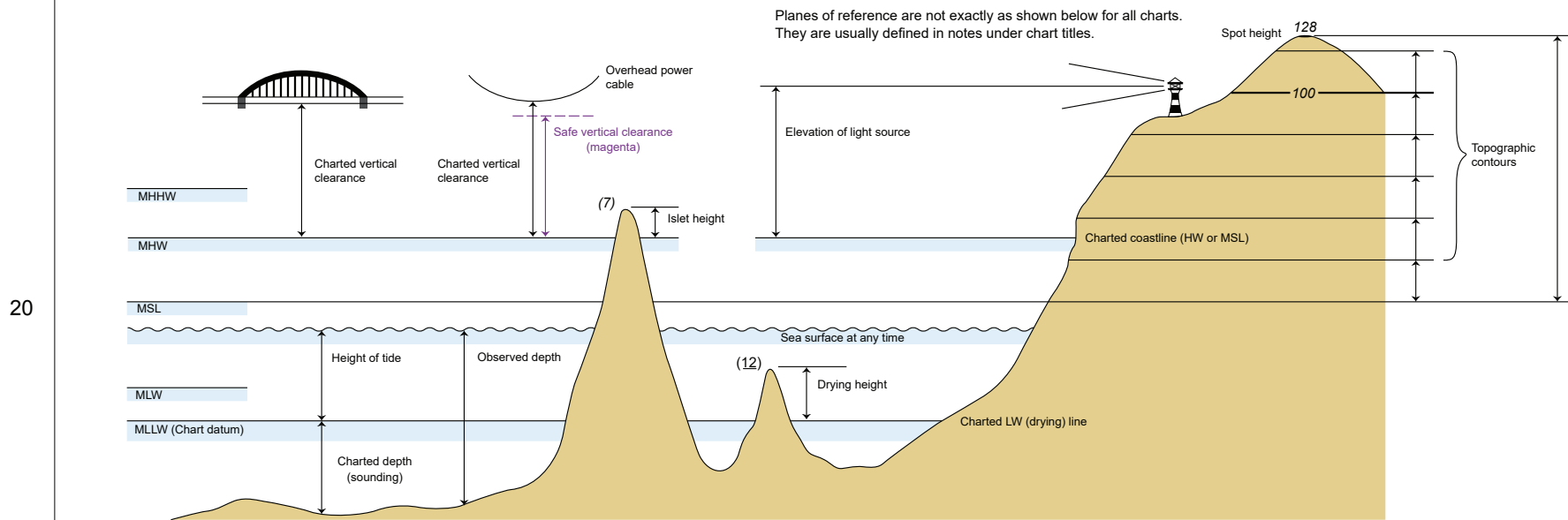





Notes:

- 1) The numbers 128, 100, (7) and (12), shown above, are examples of how spot heights, topographic contour labels, islet heights and drying heights appear on NOAA paper charts. The numbers are enclosed in parentheses if the value is offset into the water to more clearly show the islet or rock.
- 2) On NOAA charts, except for lake charts, the HW (coast) line is equal to the MHW line.

Tide Tables

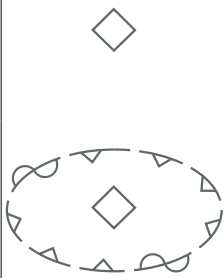

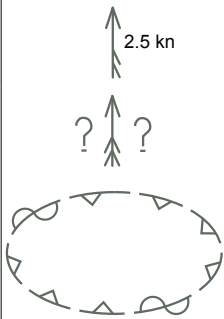

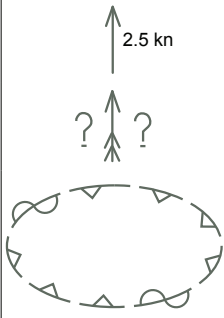











No.	INT	Description	NOAA																																																																								
30	<p>Tidal Levels referred to datum of soundings</p> <table border="1"> <thead> <tr> <th rowspan="2">Place</th> <th rowspan="2">Lat N</th> <th rowspan="2">Long E</th> <th colspan="4">Heights in metres above datum</th> </tr> <tr> <th>MHWS</th> <th>MHWN</th> <th>MLWN</th> <th>MLWS</th> </tr> </thead> <tbody> <tr> <td rowspan="2">Norderney, Riffgat Langeoog</td> <td>53°42'</td> <td>7°09'</td> <td>3.2</td> <td>2.8</td> <td>0.9</td> <td>0.4</td> </tr> <tr> <td>53°43'</td> <td>7°30'</td> <td>3.4</td> <td>3.0</td> <td>0.9</td> <td>0.4</td> </tr> <tr> <td></td> <td></td> <td></td> <th>MHHW</th> <th>MLHW</th> <th>MHLW</th> <th>MLLW</th> </tr> <tr> <td></td> <td></td> <td></td> <td></td> <td></td> <td></td> <td></td> </tr> </tbody> </table>	Place	Lat N	Long E	Heights in metres above datum				MHWS	MHWN	MLWN	MLWS	Norderney, Riffgat Langeoog	53°42'	7°09'	3.2	2.8	0.9	0.4	53°43'	7°30'	3.4	3.0	0.9	0.4				MHHW	MLHW	MHLW	MLLW								<p>Tabular statement of semi-diurnal or diurnal tides</p> <p>Note: The order of the columns of levels will be the same as that used in national tables of tidal predictions.</p>	<p>TIDAL INFORMATION</p> <table border="1"> <thead> <tr> <th rowspan="2">PLACE</th> <th rowspan="2">Height referred to datum of soundings (MLLW)</th> <th colspan="3">Height referred to datum of soundings (MLLW)</th> </tr> <tr> <th>NAME</th> <th>(LAT/LONG)</th> <th>Mean Higher High Water</th> <th>Mean High Water</th> <th>Mean Low Water</th> </tr> </thead> <tbody> <tr> <td>Baltimore, Ft. McHenry</td> <td>39°16'N/76°35'W</td> <td>feet</td> <td>feet</td> <td>feet</td> <td>feet</td> </tr> <tr> <td>Annapolis, U.S. Naval Academy</td> <td>38°59'N/76°29'W</td> <td>1.7</td> <td>1.4</td> <td>0.2</td> <td></td> </tr> <tr> <td>Washington D.C., Washington Channel</td> <td>38°52'N/77°01'W</td> <td>1.4</td> <td>1.2</td> <td>0.2</td> <td></td> </tr> <tr> <td></td> <td></td> <td>3.2</td> <td>2.9</td> <td>0.1</td> <td></td> </tr> </tbody> </table> <p>Dashes (---) located in datum columns indicate unavailable datum values for a tide station. Real-time water levels, tide predictions, and tidal current predictions are available on the Internet from http://tidesandcurrents.noaa.gov.</p> <p>(Nov 2011)</p>	PLACE	Height referred to datum of soundings (MLLW)	Height referred to datum of soundings (MLLW)			NAME	(LAT/LONG)	Mean Higher High Water	Mean High Water	Mean Low Water	Baltimore, Ft. McHenry	39°16'N/76°35'W	feet	feet	feet	feet	Annapolis, U.S. Naval Academy	38°59'N/76°29'W	1.7	1.4	0.2		Washington D.C., Washington Channel	38°52'N/77°01'W	1.4	1.2	0.2				3.2	2.9	0.1	
Place	Lat N				Long E	Heights in metres above datum																																																																					
		MHWS	MHWN	MLWN		MLWS																																																																					
Norderney, Riffgat Langeoog	53°42'	7°09'	3.2	2.8	0.9	0.4																																																																					
	53°43'	7°30'	3.4	3.0	0.9	0.4																																																																					
			MHHW	MLHW	MHLW	MLLW																																																																					
PLACE	Height referred to datum of soundings (MLLW)	Height referred to datum of soundings (MLLW)																																																																									
		NAME	(LAT/LONG)	Mean Higher High Water	Mean High Water	Mean Low Water																																																																					
Baltimore, Ft. McHenry	39°16'N/76°35'W	feet	feet	feet	feet																																																																						
Annapolis, U.S. Naval Academy	38°59'N/76°29'W	1.7	1.4	0.2																																																																							
Washington D.C., Washington Channel	38°52'N/77°01'W	1.4	1.2	0.2																																																																							
		3.2	2.9	0.1																																																																							







H Tides, Currents

No.	INT					ECDIS																																																																																							
31	Tidal stream table	<p>Tidal streams referred to . . .</p> <table border="1"> <tr> <td>Hours</td> <td colspan="4">Geographical Position</td> </tr> <tr> <td></td> <td colspan="4">53°51.2' N 7° 17.8' E</td> </tr> <tr> <td>Before High Water</td> <td>Directions of streams (degrees)</td> <td>Rates at spring tides (knots)</td> <td>Rates at neap tides (knots)</td> <td></td> </tr> <tr> <td>6</td> <td></td> <td></td> <td></td> <td>-6</td> </tr> <tr> <td>5</td> <td></td> <td></td> <td></td> <td>-5</td> </tr> <tr> <td>4</td> <td></td> <td></td> <td></td> <td>-4</td> </tr> <tr> <td>3</td> <td></td> <td></td> <td></td> <td>-3</td> </tr> <tr> <td>2</td> <td></td> <td></td> <td></td> <td>-2</td> </tr> <tr> <td>1</td> <td></td> <td></td> <td></td> <td>-1</td> </tr> <tr> <td>High Water</td> <td></td> <td></td> <td></td> <td>0</td> </tr> <tr> <td>After High Water</td> <td></td> <td></td> <td></td> <td>+1</td> </tr> <tr> <td>1</td> <td></td> <td></td> <td></td> <td>+2</td> </tr> <tr> <td>2</td> <td></td> <td></td> <td></td> <td>+3</td> </tr> <tr> <td>3</td> <td></td> <td></td> <td></td> <td>+4</td> </tr> <tr> <td>4</td> <td></td> <td></td> <td></td> <td>+5</td> </tr> <tr> <td>5</td> <td></td> <td></td> <td></td> <td>+6</td> </tr> <tr> <td>6</td> <td></td> <td></td> <td></td> <td></td> </tr> </table>					Hours	Geographical Position					53°51.2' N 7° 17.8' E				Before High Water	Directions of streams (degrees)	Rates at spring tides (knots)	Rates at neap tides (knots)		6				-6	5				-5	4				-4	3				-3	2				-2	1				-1	High Water				0	After High Water				+1	1				+2	2				+3	3				+4	4				+5	5				+6	6					 <p>Point or area for which a tidal stream table is available</p> <p>Boundary of an area for which there is tidal information</p>	
Hours	Geographical Position																																																																																												
	53°51.2' N 7° 17.8' E																																																																																												
Before High Water	Directions of streams (degrees)	Rates at spring tides (knots)	Rates at neap tides (knots)																																																																																										
6				-6																																																																																									
5				-5																																																																																									
4				-4																																																																																									
3				-3																																																																																									
2				-2																																																																																									
1				-1																																																																																									
High Water				0																																																																																									
After High Water				+1																																																																																									
1				+2																																																																																									
2				+3																																																																																									
3				+4																																																																																									
4				+5																																																																																									
5				+6																																																																																									
6																																																																																													
Tidal Streams and Currents						Supplementary national symbols: m-t																																																																																							
Breakers → K		Tide Gauge → T																																																																																											
No.	INT	Description	NOAA	NGA	Other NGA	ECDIS																																																																																							
40		Flood tide stream with mean spring rate				 <p>Flood stream, rate at spring tides</p> <p>Current or tidal stream whose direction is not known</p> <p>Boundary of an area for which there is tidal information</p>																																																																																							
41		Ebb tide stream with mean spring rate				 <p>Ebb stream, rate at spring tides</p> <p>Current or tidal stream whose direction is not known</p> <p>Boundary of an area for which there is tidal information</p>																																																																																							

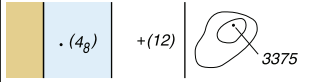
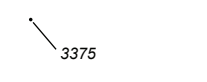
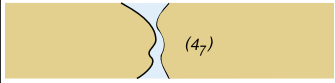
No.	INT	Description	NOAA	NGA	Other NGA	ECDIS	
42		Current in restricted waters					Non-tidal current
43		Ocean current with rates and seasons					
44		Overfalls, tide rips, races					Overfalls, tide rips; eddies; breakers as point, line, and area
45		Eddies					
46		Position of tabulated tidal stream data with designation					Point for which a tidal stream table is available
47		Offshore position for which tidal levels are tabulated					
Supplementary National Symbols (Supplementary national terms relating to tidal levels are listed after H 17)							
l		Stream		Str			
m		Current, general, with rate					
n		Velocity, Rate		vel			
o		Knots		kn			
p		Height		ht			
q		Flood		fl			
u		Gulf Stream Limits					<i>Approximate location of Axis of Gulf Stream</i>

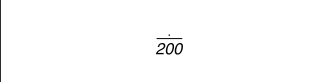
I Depths

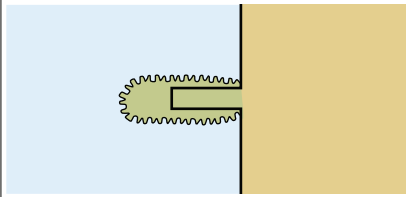
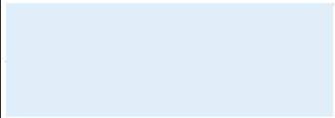
No.	INT	Description	NOAA	NGA	Other NGA	ECDIS
General						
1	ED	Existence doubtful				 Sounding of low accuracy
2	SD	Sounding of doubtful depth				   Sounding of low accuracy Underwater hazard with depth greater than 20 meters Isolated danger of depth less than the safety contour
3.1	Rep	Reported, but not confirmed				  Sounding of low accuracy Point feature or area of low accuracy
3.2	Rep (2011)	Reported (with year of report), but not confirmed				  Low accuracy line demarking area wreck or obstruction Low accuracy line demarking foul area
4	 	Reported, but not confirmed sounding or danger (on small scale charts only)				      Obstruction, depth not stated Sounding of low accuracy Underwater hazard with depth of 20 meters or less Underwater hazard with depth greater than 20 meters Isolated danger of depth less than the safety contour Point feature or area of low accuracy

No.	INT	Description	NOAA	NGA	Other NGA	ECDIS
Soundings						Supplementary national symbols: a–c
Plane of Reference for Depths → H			Plane of Reference for Heights → H			
10	12 9 ₇	Soundings in true position (NOAA shows fathoms and feet with vertical numbers and meters with sloping numbers)	12 3 ₂ 2 ₂ ¹			9 ₇ 30 Sounding shoaler than or equal to safety depth Sounding deeper than safety depth
11		Soundings out of position	(23)			Depths are always shown in their true position in ECDIS
12		Least depth in narrow channel				
13		No bottom found at depth shown				200  Status of no bottom found is obtained by cursor pick
14	12 9 ₇	Soundings which are unreliable or taken from a smaller scale source (NOAA shows unreliable soundings in fathoms and feet with sloping numbers and in meters with vertical numbers)				12 9 ₇ Sounding of low accuracy
15		Drying heights and contours above chart datum				4 Drying height, less than or equal to safety depth
16		Natural watercourse (in intertidal area)				 Tideway



ECDIS depth related symbols closely resemble their paper chart counterparts; however, ECDIS provides valuable additional information to mariners that paper charts cannot.

Soundings

ECDIS enables mariners to set their own-ship “safety depth.” If no depth is set, ECDIS sets the value to 30m. Soundings equal to or shoaler than the safety depth are shown in black; deeper soundings are displayed in a less conspicuous gray. Fractional values are shown with subscript numbers of the same size.

Depth Contours & Depth Areas

Depth contours in ECDIS are portrayed with a thin gray line. Each pair of adjacent depth contours is used to create depth area features. These are used by ECDIS to tint different depth levels and to initiate alarms when a ship is headed into unsafe water.

Depth Contour Labels



ECDIS depth contour labels are not centered and oriented along isolines as they appear on paper charts. They are displayed upright and may appear either on or next to the contour lines that they describe. The labels are black and the same size as soundings, but the labels have a light “halo” to set them apart. The graphic to the left shows depth labels and soundings both deeper and shoaler than the safety depth. Note that depths on NOAA paper charts and ENCs are usually compiled in fathoms and feet. Because ECDIS displays depths in meters, soundings and contour lines often show fractional meter values. The “own-ship safety contour” (described below) is always displayed, but mariners may choose to have all other depth contours turned off.

Safety Contour

ECDIS uses a “safety contour” value to show an extra thick line for the depth contour that separates “safe water” from shoaler areas. If the mariner does not set an own-ship safety contour value, ECDIS sets the value to 30m. If the ENC being displayed does not have a contour line equal to the safety contour depth value set by the mariner, then ECDIS sets the next deeper contour as the safety contour. Depending on the contour intervals used on individual ENCs, ECDIS may set different safety contours as a ship transits from one ENC to another. ECDIS will initiate an alarm if the ship’s future track will cross the safety contour within a specified time set by the mariner.

Two or Four Tints for Shading Depth Areas

ECDIS tints all depth areas beyond the (green tinted) foreshore in either one of two or one of four shades of blue. This is similar to the convention used for paper charts, but the depths used to change from one tint to another are based on the safety contour and thus “customized” for each ship. If the mariner chooses two shades to be displayed, water deeper than the safety contour is shown in an off-white color, water shoaler than the safety contour is tinted blue.

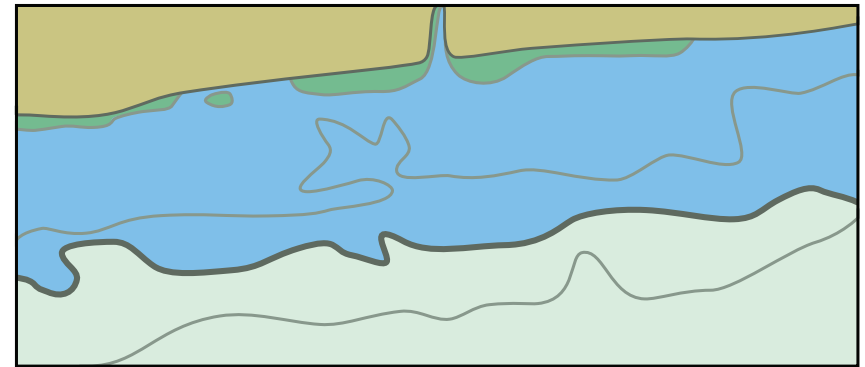

Portrayal of Depth Areas with 2 Color Settings

Some ECDIS enable mariners to define two additional depth areas for medium-deep water and medium-shallow water by setting a “deep contour” value and a “shallow contour” value. If this option is used, the safety contour is displayed between the medium deep and medium shallow contours.

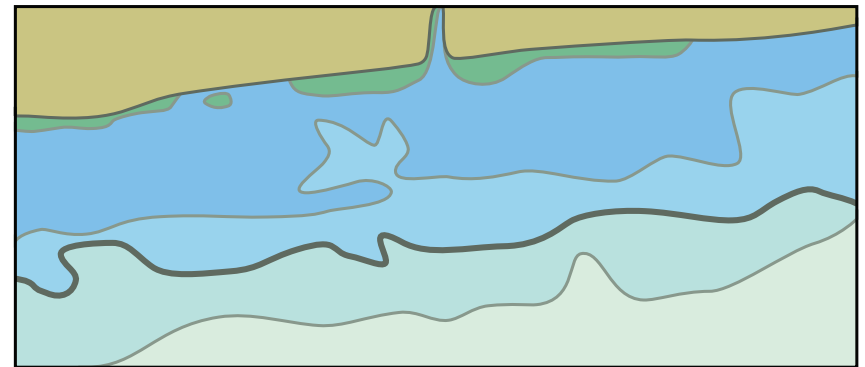

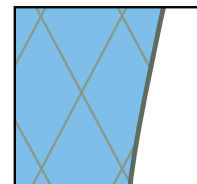

Portrayal of Depth Areas with 4 Color Setting



Some ECDIS also provide the mariner with the option of displaying a cross-hatch “shallow water” pattern over all depth areas shoaler than the safety contour.

I Depths

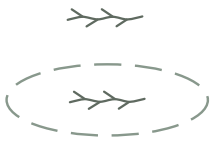
No.	INT	Description	NOAA	NGA	Other NGA	ECDIS
Depth Contours						
30		<p>Drying contour Low water line</p> <p>Blue tint, in one or more shades, or tint ribbons are shown to different limits according to the scale and purpose of the chart and the nature of the bathymetry.</p> <p>On some charts, contours and values are printed in blue.</p>				
31		Approximate depth contours				<p>Approximate depth contour</p> <p>Approximate safety depth contour</p>
Supplementary National Symbols						
a		Swept channel				
b		Swept area, not adequately sounded (shown by purple or green tint)				
c		Stream				

No.	INT	Description	NOAA	NGA	Other NGA	ECDIS	
Types of Seabed						Supplementary national abbreviations: a–ag	
Rocks → K							
1	<i>S</i>	Sand				<i>S</i>	Sand
2	<i>M</i>	Mud				<i>M</i>	Mud
3	<i>Cy</i>	Clay				<i>Cy</i>	Clay
4	<i>Si</i>	Silt				<i>Si</i>	Silt
5	<i>St</i>	Stones				<i>St</i>	Stones
6	<i>G</i>	Gravel				<i>G</i>	Gravel
7	<i>P</i>	Pebbles				<i>P</i>	Pebbles
8	<i>Cb</i>	Cobbles				<i>Cb</i>	Cobbles
9.1	<i>R</i>	Rock; Rocky		<i>Rk; rky</i>		<i>R</i>	Rock
9.2	<i>Bo</i>	Boulder(s)		<i>Blds</i>		<i>R</i>	Boulder
						<i>R</i>	Lava
10	<i>Co</i>	Coral, Coralline algae				<i>Co</i>	Coral
11	<i>Sh</i>	Shells (skeletal remains)				<i>Sh</i>	Shells
12.1	<i>S/M</i>	Two layers, e.g. sand over mud					
12.2	<i>fS M Sh</i> <i>fS.M.Sh</i>	The main constituent is given first for mixtures, e.g. fine sand with mud and shells	<i>f S M Sh</i>				
13.1	<i>Wd</i>	Weed (including kelp)					Weed, kelp
13.2		Kelp, Weed		 <i>Kelp</i>			Weed, kelp as an area
13.3	<i>Sg</i>	Seagrass					

J Nature of the Seabed









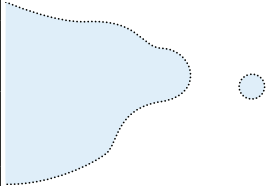
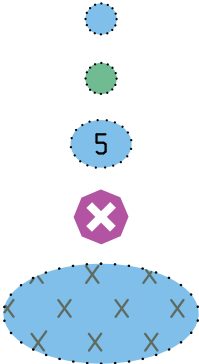

No.	INT	Description	NOAA	NGA	Other NGA	ECDIS	
14		Sandwaves		Sandwaves			Sand waves as a point
							Sand waves as a line
							Sand waves as an area
15		Spring in seabed		Spring			Spring
Types of Seabed, Intertidal Areas							
20		Area with stones and gravel					Areas of gravel and stone
21		Rocky area, which covers and uncovers					Rocky ledges or coral reef
22		Coral reef, which covers and uncovers					
Qualifying Terms							
30	<i>f</i>	Fine	} only used in relation to sand				Supplementary national symbols: ah–bf
31	<i>m</i>	Medium					
32	<i>c</i>	Coarse					
33	<i>bk</i>	Broken					
34	<i>sy</i>	Sticky					
35	<i>so</i>	Soft					
36	<i>sf</i>	Stiff					
37	<i>v</i>	Volcanic		<i>vol</i>			
38	<i>ca</i>	Calcareous		<i>Ca</i>			Rocky ledges or coral reef
39	<i>h</i>	Hard					

No.	INT	Description	NOAA	NGA	Other NGA	ECDIS
Supplementary National Abbreviations						
a		Ground		<i>Grd</i>		
b		Ooze		<i>Oz</i>		
c		Marl		<i>Ml</i>		
d		Shingle		<i>Sn</i>		
f		Chalk		<i>Ck</i>		
g		Quartz		<i>Qz</i>		
h		Schist		<i>Sch</i>		
i		Coral head		<i>Co Hd</i>		
j		Madrepores		<i>Mds</i>		
k		Volcanic ash		<i>Vol Ash</i>		
l		Lava		<i>La</i>		
m		Pumice		<i>Pm</i>		
n		Tufa		<i>T</i>		
o		Scoriae		<i>Sc</i>		
p		Cinders		<i>Cn</i>		
q		Manganese		<i>Mn</i>		
r		Oysters		<i>Oys</i>		
s		Mussels		<i>Ms</i>		
t		Sponge		<i>Spg</i>		
u		Kelp		<i>K</i>		
v		Grass		<i>Grs</i>		
w		Sea-tangle		<i>Stg</i>		
x		Spicules		<i>Spi</i>		
y		Foraminifera		<i>Fr</i>		
z		Globigerina		<i>Gl</i>		
aa		Diatoms		<i>Di</i>		
ab		Radiolaria		<i>Rd</i>		
ac		Pteropods		<i>Pt</i>		
ad		Polyzoa		<i>Po</i>		
ae		Cirripedia		<i>Cir</i>		
af		Fucus		<i>Fu</i>		

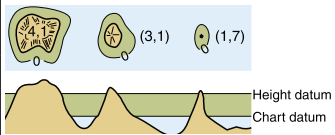
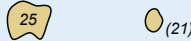
J Nature of the Seabed

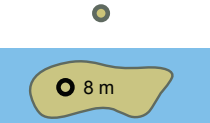
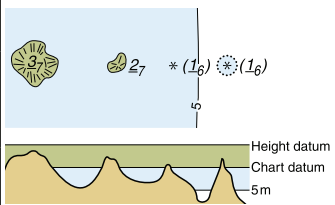
No.	INT	Description	NOAA	NGA	Other NGA	ECDIS
ag		Mattes		<i>Ma</i>		
ah		Small		<i>sml</i>		
ai		Large		<i>lrg</i>		
aj		Rotten		<i>rt</i>		
ak		Streaky		<i>str</i>		
al		Speckled		<i>spk</i>		
am		Gritty		<i>gty</i>		
an		Decayed		<i>dec</i>		
ao		Flinty		<i>fly</i>		
ap		Glacial		<i>glac</i>		
aq		Tenacious		<i>ten</i>		
ar		White		<i>wh</i>		
as		Black		<i>bl; bk</i>		
at		Violet		<i>vi</i>		
au		Blue		<i>bu</i>		
av		Green		<i>gn</i>		
aw		Yellow		<i>yl</i>		
ax		Orange		<i>or</i>		
ay		Red		<i>rd</i>		
az		Brown		<i>br</i>		
ba		Chocolate		<i>ch</i>		
bb		Gray		<i>gy</i>		
bc		Light		<i>lt</i>		
bd		Dark		<i>dk</i>		
be		Varied		<i>vard</i>		
bf		Uneven		<i>unev</i>		

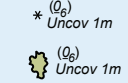
Rocks, Wrecks, Obstructions and Aquaculture K

No.	INT	Description	NOAA	NGA	Other NGA	ECDIS	
General							
1		Danger line: A danger line draws attention to a danger which would not stand out clearly enough if represented solely by its symbol (e.g. isolated rock) or delimits an area containing numerous dangers, through which it is unsafe to navigate					<p>Obstruction, depth not stated</p> <p>Obstruction which covers and uncovers</p> <p>Underwater hazard with depth of 20 meters or less</p> <p>Isolated danger of depth less than the safety contour</p> <p>Foul area, not safe for navigation</p>
2		Depth swept by wire drag or confirmed by diver (This symbol may be combined with other symbols, e.g. wrecks, obstructions, wells.)	<u>21</u> Rk <u>35</u> Rk <u>4</u> Obstn <u>4</u> Wk <u>4</u> Wk (1937)		<u>#</u> (15 ₇)		<p>Swept sounding, less than or equal to safety depth</p> <p>Swept sounding, greater than safety depth</p>
3		Safe clearance depth. The exact depth is unknown, but is estimated to have a safe clearance at the depth shown	<u>4</u> Wk <u>35</u> Rk <u>4</u> Obstn			ECDIS displays safe clearance depths in the same manner as known depths.	
Rocks							
Plane of Reference for Heights → H		Plane of Reference for Depths → H					
10		Rock (islet) which does not cover, height above height datum					<p>Land as a point at small scale</p> <p>Land as an area, with an elevation or control point</p>
11		Rock which covers and uncovers, height above chart datum					<p>Rock which covers and uncovers or is awash at low water</p> <p>Underwater hazard which covers and uncovers with drying height</p> <p>Isolated danger of depth less than the safety contour</p>

K Rocks, Wrecks Obstructions and Aquaculture

No.	INT	Description	NOAA	NGA	Other NGA	ECDIS	
12		Rock awash at the level of chart datum					<p>Rock which covers and uncovers or is awash at low water</p> <p>Underwater hazard which covers and uncovers</p> <p>Isolated danger of depth less than the safety contour</p>
13		Underwater rock of unknown depth, dangerous to surface navigation					Dangerous underwater rock of uncertain depth
14		Underwater rock of known depth					
14.1		inside the corresponding depth area	12 Rk	27 Rk 21 R			Underwater hazard with a depth of 20 meters or less
14.2		outside the corresponding depth area, dangerous to surface navigation	Rk	Rk R			Underwater hazard with depth greater than 20 meters
15	35 R	Underwater rock of known depth, not dangerous to surface navigation	35Rk		35 _R + (35)		Underwater hazard with a depth of 20 meters or less
							Underwater hazard with depth greater than 20 meters

Rocks, Wrecks, Obstructions and Aquaculture K

No.	INT	Description	NOAA	NGA	Other NGA	ECDIS
16		Coral Reef which is always covered				<p>Dangerous underwater rock of uncertain depth Obstruction, depth not stated Isolated danger of depth less than the safety contour Safe clearance shoaler than safety contour Safe clearance deeper than safety contour Safe clearance deeper than 20 meters</p>
17		Breakers				<p>Overfalls, tide rips; eddies; breakwaters as point, line, and area</p>
Wrecks and Fouls						
Plane of Reference for Depths → H						
20		Wreck, hull never covers, on large scale charts, height above height datum				Wreck, always dry, with height shown
21		Wreck, covers and uncovers, on large scale charts, height above chart datum				Wreck, covers and uncovers Distributed remains of wreck



































K Rocks, Wrecks Obstructions and Aquaculture

No.	INT	Description	NOAA	NGA	Other NGA	ECDIS
22		Submerged wreck, depth known, on large scale charts				 Submerged wreck with depth of 20 meters or less Submerged wreck with depth greater than 20 meters Distributed remains of wreck
23		Submerged wreck, depth unknown, on large scale charts			 	 Submerged wreck with depth less than the safety contour or depth unknown
24		Wreck showing any portion of hull or superstructure at level of chart datum			 	 Wreck showing any portion of hull or superstructure at level of chart datum
25		Wreck of which the mast(s) only are visible at chart datum				
26		Wreck, least depth known by sounding only				 Underwater hazard with depth of 20 meters or less Underwater hazard with depth greater than 20 meters Isolated danger of depth less than the safety contour
27		Wreck, depth swept by wire drag or confirmed by diver				 Swept sounding for underwater hazard less than safety depth Swept sounding for underwater hazard greater than or equal to safety depth Isolated danger of depth less than the safety contour



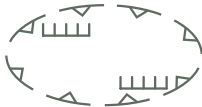









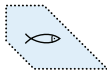
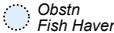
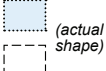



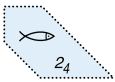
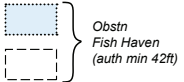

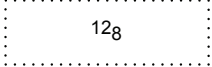
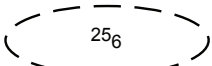

Rocks, Wrecks, Obstructions and Aquaculture K

No.	INT	Description	NOAA	NGA	Other NGA	ECDIS	
28		Dangerous wreck, depth unknown					Dangerous wreck, depth unknown
29		Sunken wreck, not dangerous to surface navigation					Non-dangerous wreck, depth unknown
30		Wreck over which the exact depth is unknown, but which is estimated to have a safe clearance at the depth shown.					Underwater hazard with safe clearance of 20 meters or less
							Underwater hazard with safe clearance greater than 20 meters
							Isolated danger of depth less than the safety contour
31.1		Foul ground, not dangerous to surface navigation, but to be avoided by vessels anchoring, trawling, etc. (e.g. remains of wreck, cleared platform)					Foul area of seabed safe for navigation but not for anchoring
31.2							Foul ground
							Distributed remains of wreck
Obstructions and Aquaculture							
Plane of Reference for Depths → H		Kelp, Seaweed → J	Underwater Installations → L				
40		Obstruction, depth unknown					Obstruction, depth not stated
							Isolated danger of depth less than the safety contour
							Safe clearance shoaler than safety contour

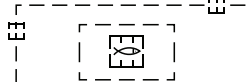
K Rocks, Wrecks Obstructions and Aquaculture

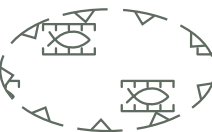
No.	INT	Description	NOAA	NGA	Other NGA	ECDIS	
41	 <i>Obstn</i>  <i>Obstn</i>	Obstruction, least depth known by sounding only				  	<p>Underwater hazard with depth of 20 meters or less</p> <p>Underwater hazard with depth greater than 20 meters</p> <p>Isolated danger of depth less than the safety contour</p>
42	 <i>Obstn</i>  <i>Obstn</i>	Obstruction, depth swept by wire drag or confirmed by diver				 } swept depth  }  } known by diver or other means  } 	<p>Less than or equal to safety depth</p> <p>Greater than safety depth</p> <p>Method of depth measurement is obtained by cursor pick</p> <p>Underwater hazard with depth of 20 meters or less</p> <p>Underwater hazard with depth greater than 20 meters</p> <p>Isolated danger of depth less than the safety contour</p>
43.1	  <i>Obstn</i>	Stumps of posts or piles, wholly submerged		 <i>Piles</i>	 		Obstruction, depth not stated
43.2		Submerged pile, stake, snag, or stump (with exact position)	 	  	 	<p>Underwater hazard with depth of 20 meters or less</p> <p>Isolated danger of depth less than the safety contour</p>	
44.1		Fishing stakes				 	<p>Fish stakes as a point</p> <p>Fish stakes as an area</p>
44.2		Fish trap, Fish weir, Tunny nets	Fish trap 				Fish trap, fish weir, tunny net as a point

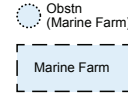
Rocks, Wrecks, Obstructions and Aquaculture K















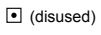



















No.	INT	Description	NOAA	NGA	Other NGA	ECDIS	
45		Fish trap area, Tunny nets area					Fish trap, fish weir, tunny net as an area
46.1		Fish haven					Isolated danger of depth less than the safety contour
							Safe clearance shoaler than safety contour
46.2		Fish haven with minimum depth					Underwater hazard with depth of 20 meters or less
							Underwater hazard with depth greater than 20 meters
							Isolated danger of depth less than the safety contour
							Safe clearance shoaler than safety contour
	Safe clearance deeper than safety contour						
	Safe clearance deeper than 20 meters						
47		Shellfish beds					Marine farm as a point
48.1		Marine farm (on large scale charts), area of marine farms					Marine farm as an area
48.2		Marine farm (on small scale charts)					
Supplementary National Symbols							
a		Rock which covers and uncovers, (height unknown)	* 				



































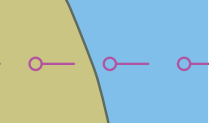
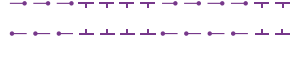

K Rocks, Wrecks Obstructions and Aquaculture

No.	INT	Description	NOAA	NGA	Other NGA	ECDIS	
b		Shoal sounding on isolated rock or rocks			 		
c		Sunken wreck covered 20 to 30 meters	++				
d		Submarine volcano		<i>Sub vol</i>			
e		Discolored water		<i>Discol water</i>			
f		Sunken danger, least depth cleared by wire drag	<u>21</u> <i>Rk</i> <u>35</u> <i>Rk</i> <i>Obstn</i>				
g		Reef of unknown extent	<i>Reef</i>				
h		Coral reef, detached (uncovers at sounding datum)	<i>Co</i>				
i		Submerged crib	<i>Subm Crib</i>	<i>Crib</i>			
j		Crib, duck blind (above water)	■ Duck Blind ■ Crib				
k		Submerged duck blind	<i>Duck Blind</i>				
l		Submerged platform	<i>Subm platform</i>	<i>Platform</i>			
m		Coral reef which covers and uncovers					
n		Sinkers					
o		Foul area, foul with rocks or wreckage, dangerous to navigation					
p		Unexploded ordnance					
q		Float	<i>Float</i>				
r		Stumps of posts or piles, which cover and uncover					

No.	INT	Description	NOAA	NGA	Other NGA	ECDIS	
General							
Areas, Limits → N							
1	<i>Ekofisk Oilfield</i>	Name of oilfield or gasfield					Area to be navigated with caution, name is obtained by cursor pick
2		Platform with designation/name					Offshore platform, name is obtained by cursor pick
3		Limit of safety zone around offshore installation					Area where entry is prohibited or restricted or to be avoided, with other cautions
4		Limit of development area					Cautionary area, navigate with caution
5.1		Wind turbine, floating wind turbine, vertical clearance under blade					Wind motor visually conspicuous
5.2		Offshore wind farm					Wind farm (offshore)
		Offshore wind farm (floating)					
6		Wave farm, Renewable energy device					Wave farm
Platforms and Moorings							
Mooring Buoys → Q							
10		Production platform, Platform, Oil derrick					Offshore platform
11		Flare stack (at sea)					Conspicuous flare stack on offshore platform

L Offshore Installations

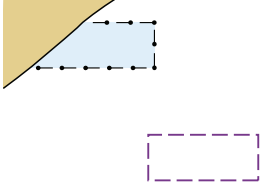
No.	INT	Description	NOAA	NGA	Other NGA	ECDIS	
12		Single Point Mooring (SPM), including Single Anchor Leg Mooring (SALM), Articulated Loading Column (ALC)					Offshore platform, name and status of disused is obtained by cursor pick
14	 	Disused platform with superstructure removed					
16		Single Buoy Mooring (SBM), Oil or gas installation buoy including Catenary Anchor Leg Mooring (CALM)				 	Installation buoy and mooring buoy, simplified Installation buoy, paper chart
17		Moored storage tanker, Accommodation vessel		 <i>Tanker</i>			Offshore platform
18		Mooring ground tackle					Ground tackle
Underwater Installations						Supplementary national symbol: a	
Plane of Reference for Depths → H		Obstructions → K					
20		Submerged production well	 <i>Well (cov 21ft)</i>  <i>Well (cov 83ft)</i> 		 <i>15: Prod Well</i>  <i>Prod Well</i>	  	Underwater hazard with depth of 20 meters or less Underwater hazard with depth greater than 20 meters Isolated danger of depth less than the safety contour
21.1		Suspended well, depth over wellhead unknown	 <i>Pipe</i>				Isolated danger of depth less than the safety contour
21.2	 	Suspended well, with depth over wellhead	 <i>Pipe (cov 24ft)</i>  <i>Pipe (cov 92ft)</i>			  	Underwater hazard with depth of 20 meters or less Underwater hazard with depth greater than 20 meters Isolated danger of depth less than the safety contour













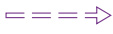





No.	INT	Description	NOAA	NGA	Other NGA	ECDIS	
22	#	Site of cleared platform				#	Foul area of seabed safe for navigation but not for anchoring
23	 Pipe  Pipe (1g)	Above-water wellhead (lit or unlit)	 Pipe		 Pipe (24)		Obstruction in the water which is always above water level
24	 Turbine  FI(2) Underwater Turbine	Underwater turbine				 	Underwater turbine or subsurface ODAS
25	 ODAS	Subsurface Ocean(ographic) Data Acquisition System ODAS				 	
Submarine Cables							
30.1		Submarine cable					Submarine cable
30.2		Submarine cable area	 Cable Area				
31.1		Submarine power cable					Submarine cable area
31.2		Submarine power cable area					
32		Disused submarine cable					Status of disused is obtained by cursor pick
Submarine Pipelines							
40.1	  Oil  Gas <i>(see Note)</i>  Chem  Water	Supply pipeline: unspecified, oil, gas, chemicals, water					Oil, gas pipeline, submerged or on land
40.2	  Oil  Gas <i>(see Note)</i>  Chem  Water	Supply pipeline area: unspecified, oil, gas, chemicals, water	 Pipeline Area				Submarine pipeline area with potentially dangerous contents

L Offshore Installations

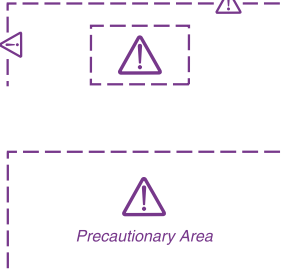
No.	INT	Description	NOAA	NGA	Other NGA	ECDIS
41.1		Outfall and intake: unspecified, water, sewer, outfall, intake				<p>Water pipeline, sewer, etc.</p>
41.2		Outfall and intake area: unspecified, water, sewer, outfall, intake				<p>Submarine pipeline area with generally non-dangerous contents</p>
42.1		Buried pipeline/pipe (with nominal depth to which buried)				<p>Nominal depth of buried pipeline is obtained by cursor pick</p>
42.2		Pipeline tunnel				<p>Pipeline tunnel</p>
43		Diffuser, Crib				<p>Underwater hazard with depth of 20 meters or less Isolated danger of depth less than the safety contour</p>
44		Disused pipeline/pipe				<p>Status of disused is obtained by cursor pick</p>
Supplementary National Symbols						
a		Submerged well (buoyed)				
b		Potable water intake				

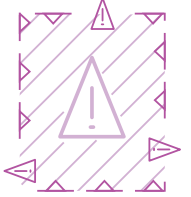
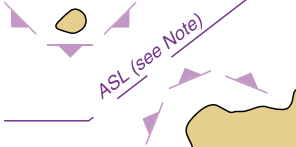
No.	INT	Description	NOAA	NGA	Other NGA	ECDIS
Tracks						
Supplementary national symbols: a–c						
Tracks Marked by Lights → P			Leading Beacons → Q			
1		Leading line (solid line is the track to be followed, ‡ means "in line")				Leading line bearing a non-regulated, recommended track
2		Transit (other than leading line), clearing line				
3		Recommended track based on a system of fixed marks				Non-regulated, recommended track based on fixed marks
4		Recommended track not based on a system of fixed marks				Non-regulated, recommended track not based on fixed marks
5.1		One-way track and DW track based on a system of fixed marks				Based on fixed marks, one-way
5.2		One-way track and DW track not based on a system of fixed marks				Not based on fixed marks, one-way
6		Recommended track with maximum authorized (or recommended) draft stated				

M Tracks, Routes

No.	INT	Description	NOAA	NGA	Other NGA	ECDIS
Routing Measures						Supplementary national symbols: d-e
Basic Symbols						
10		Established (mandatory) direction of traffic flow				 Traffic direction in a one-way lane of a traffic separation scheme
11		Recommended direction of traffic flow				 Single traffic direction in a two-way route part of a traffic-separation scheme
12		Separation line (large scale, small scale)				 Traffic separation line
13		Separation zone				 Traffic separation zone
14		Limit of restricted routing measure (e.g. Inshore Traffic Zone (ITZ), Area to be Avoided (ATBA))	 <i>RESTRICTED AREA</i>			
15		Limit of routing measure				 Traffic separation scheme boundary
16		Precautionary area				 Traffic precautionary area as a point
						 Traffic precautionary area as an area
17		Archipelagic Sea Lane (ASL); axis line and limit beyond which vessels shall not navigate				 Axis and boundary of archipelagic sea lane
18		Fairway designated by regulatory authority:				
		with minimum depth	 <i>SAFETY FAIRWAY 166.200 (see note A)</i>			

Examples of Routing Measures on Paper/Raster Charts

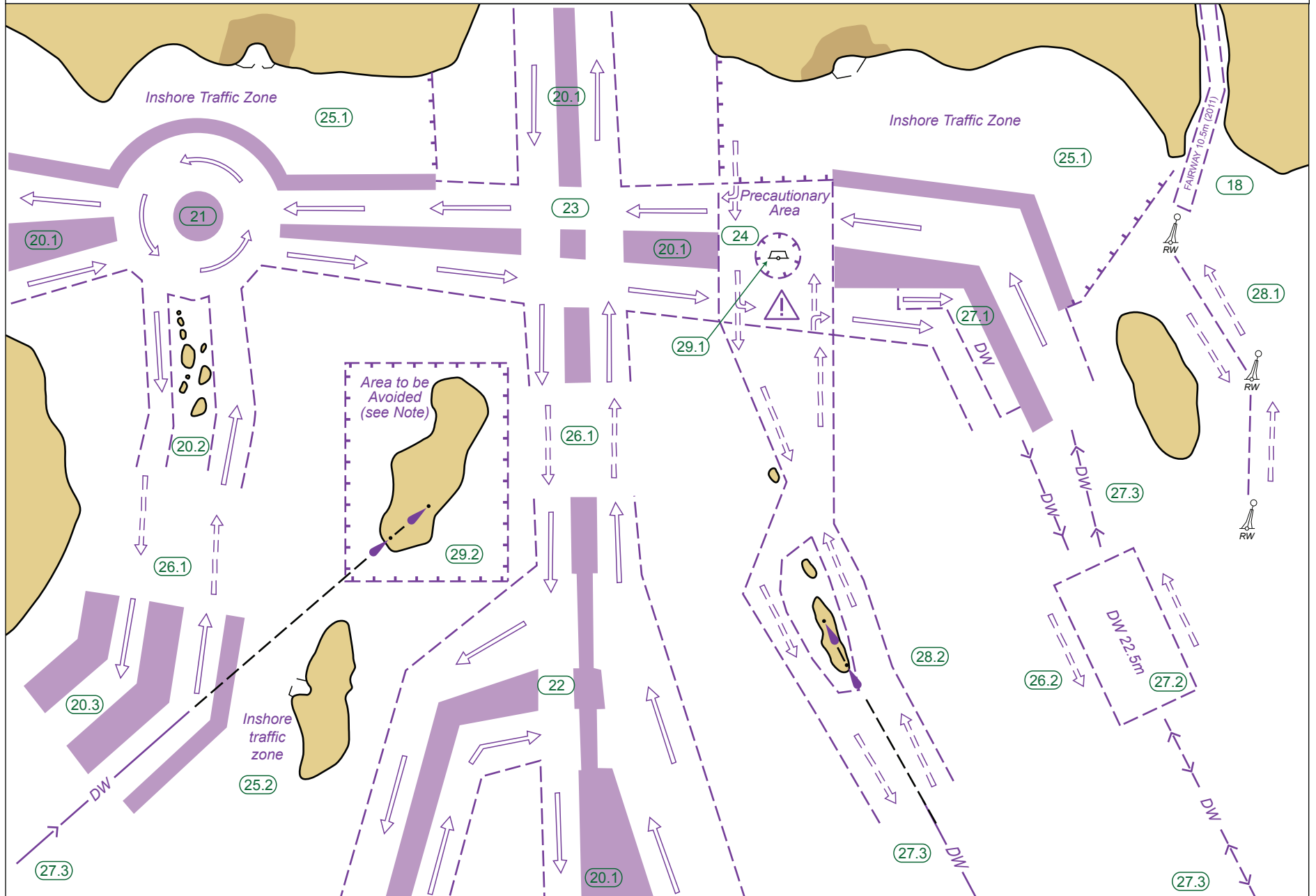





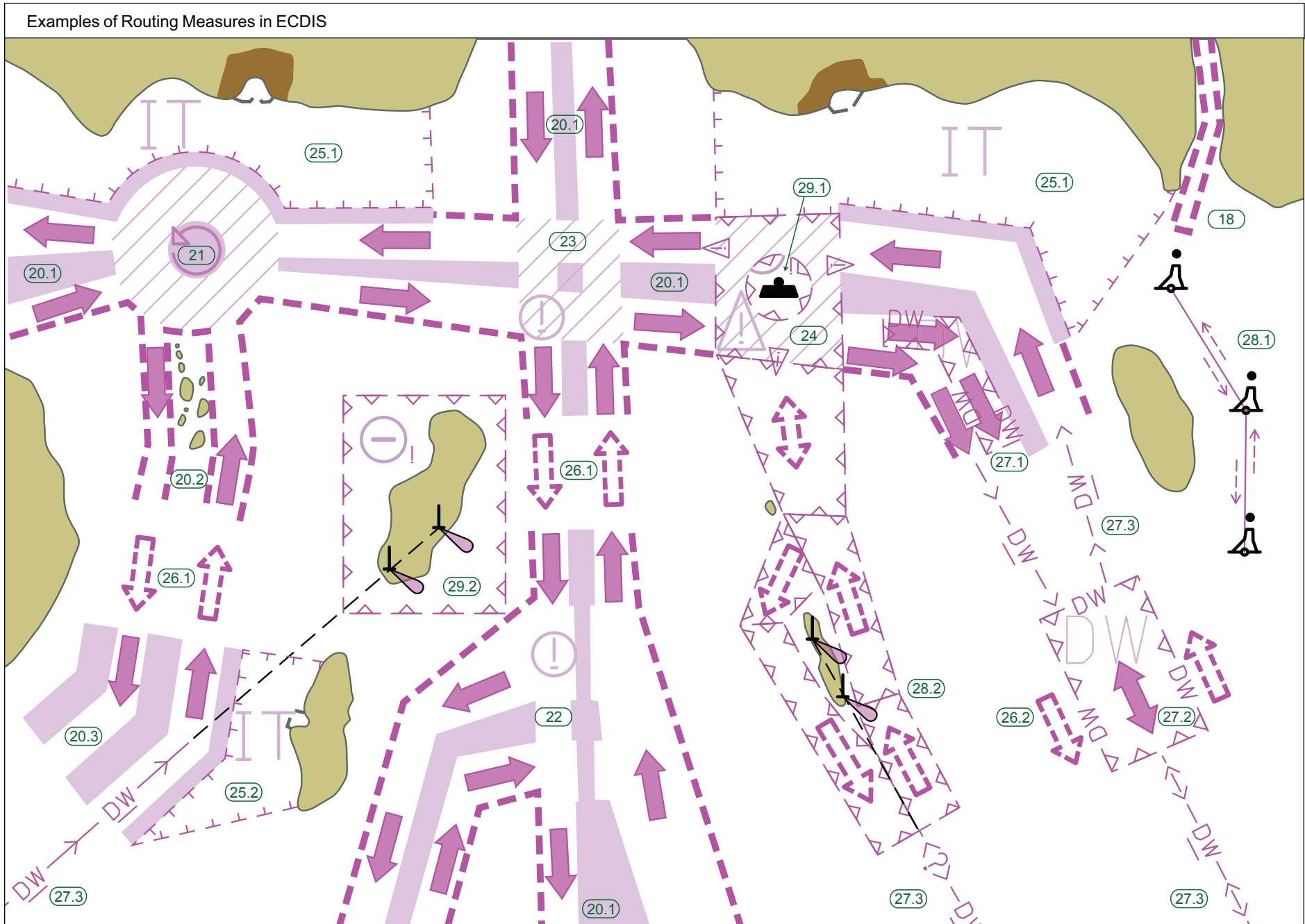





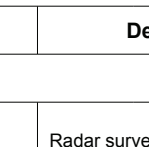
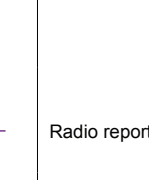







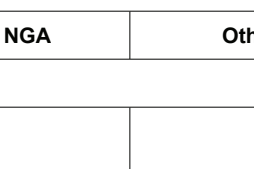





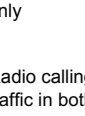

M Tracks, Routes

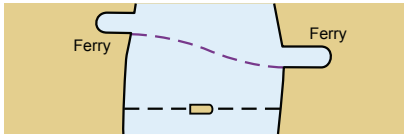
No.	
Examples of Routing Measures	
(18)	Safety fairway
(20.1)	Traffic Separation Scheme (TSS), traffic separated by separation zone
(20.2)	Traffic Separation Scheme, traffic separated by natural obstructions
(20.3)	Traffic Separation Scheme, with outer separation zone separating traffic using scheme from traffic not using it
(21)	Traffic Separation Scheme, roundabout with separation zone
(22)	Traffic Separation Scheme, with "crossing gates"
(23)	Traffic Separation Scheme crossing, without designated precautionary area
(24)	Precautionary area
(25.1)	Inshore Traffic Zone (ITZ), with defined end limits
(25.2)	Inshore Traffic Zone, without defined end limits
(26.1)	Recommended direction of traffic flow, between traffic separation schemes
(26.2)	Recommended direction of traffic flow, for ships not needing a deep water route
(27.1)	Deep water route (DW), as part of one-way traffic lane
(27.2)	Two-way deep water route, with minimum depth stated
(27.3)	Deep water route, centerline as recommended one-way or two-way track
(28.1)	Recommended route, one-way and two-way (often marked by centerline buoys)
(28.2)	Two-way route, with one-way sections
(29.1)	Area to be Avoided (ATBA), around navigational aid
(29.2)	Area to be Avoided, e.g. because of danger of stranding



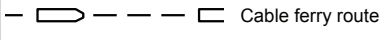







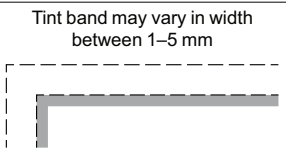
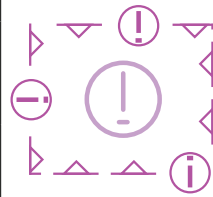



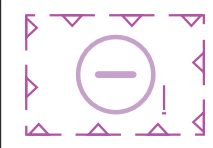
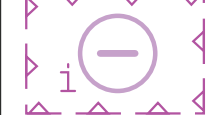
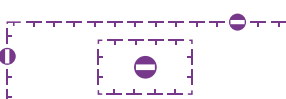





M Tracks, Routes



No.	INT	Description	NOAA	NGA	Other NGA	ECDIS
Radar Surveillance Systems						
30	 Radar Surveillance Station	Radar surveillance station				 Radar station
31		Radar range				 Radar range
32.1		Radar reference line				 Radar line
32.2		Radar reference line coinciding with a leading line				Non-regulated recommended track based on fixed marks  Direction not encoded  One-way  Two-way
Radio Reporting Points						
40.1		Radio reporting (calling-in or way) points showing direction(s) of vessel movement with designation (if any) and VHF-channel				 Radio calling-in point for traffic in one direction only  Radio calling-in point for traffic in both directions  Radio calling-in point, direction not encoded
40.2		Radio reporting line				 Radio calling-in point for traffic in one direction only  Radio calling-in point for traffic in both directions  Radio calling-in point, direction not encoded

No.	INT	Description	NOAA	NGA	Other NGA	ECDIS
Ferries						
50		Ferry				
51		Cable Ferry				
Supplementary National Symbols						
a		Recommended track for deep draft vessels (track not defined by fixed marks)				
b		Depth is shown where it has been obtained by the cognizant authority				
c		Alternate course				

N Areas, Limits

No.	INT	Description	NOAA	NGA	Other NGA	ECDIS	
General *							
Dredged and Swept Areas → I		Submarine Cables, Submarine Pipelines → L	Tracks, Routes → M				
On multi-colored charts, symbols in Section N may be in green when associated with environmental areas.							
1.1		Maritime limit in general usually implying permanent physical obstructions (tint band for emphasis)					Caution area, a specific caution note applies
1.2		usually implying no permanent physical obstructions (tint band for emphasis)					
2.1		Limit of restricted area (tint band for emphasis)				  	Area where entry is prohibited or restricted or to be avoided
2.2		Limit of area into which entry is prohibited					Area where entry is prohibited or restricted or to be avoided, with other cautions
							Area where entry is prohibited or restricted or to be avoided, with other information
Anchorages, Anchorage Areas							
10		Reported anchorage (no defined limits)					Anchorage area as a point at small scale, or anchor points of mooring trot at large scale
11.1		Anchor berths					Anchor berth
11.2		Anchor berths with swinging circle					Radius of swing circle is obtained by cursor pick

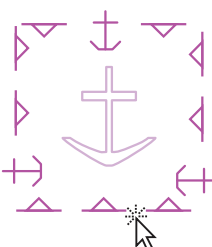
* ECDIS represents many types of area limits with just a few different symbols. Information about the type of area and its associated restrictions or prohibitions may be obtained by cursor pick.

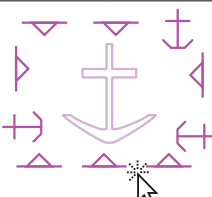















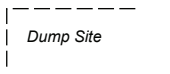



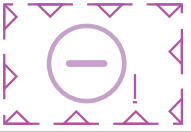



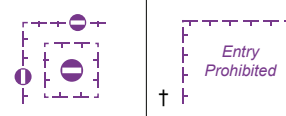

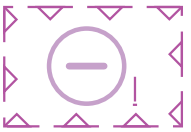
No.	INT	Description	NOAA	NGA	Other NGA	ECDIS
12.1		Anchorage area in general				 <p>Type of anchorage area is obtained by cursor pick</p>
12.2		Numbered anchorage area				
12.3		Named anchorage area				
12.4		Deep water anchorage area, Anchorage area for deep draft vessels				
12.5		Tanker anchorage area				
12.6		Anchorage area for periods up to 24 hours				
12.7		Dangerous cargo anchorage area				
12.8		Quarantine anchorage area				
12.9		Reserved anchorage area				
<p>Note: Anchors as part of the limit symbol are not shown for small areas. Other types of anchorage areas may be shown.</p>						
13		Seaplane operating area				 <p>Seaplane landing area</p>
14		Anchorage for seaplanes				 <p>Type of anchorage area is obtained by cursor pick</p>

N Areas, Limits

No.	INT	Description	NOAA	NGA	Other NGA	ECDIS	
Restricted Areas						Supplementary national symbols: d, e, g	
On multi-colored charts, the magenta symbols may be in green when associated with environmental areas.							
20		Anchoring prohibited					Area where anchoring is prohibited or restricted
							Area where anchoring is prohibited or restricted, with other cautions
							Area where anchoring is prohibited or restricted, with other information
21.1		Fishing prohibited					Area where fishing or trawling is prohibited or restricted
							Area where fishing or trawling is prohibited or restricted, with other cautions
							Area where fishing or trawling is prohibited or restricted, with other information



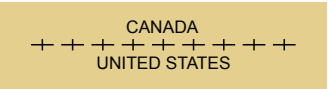



No.	INT	Description	NOAA	NGA	Other NGA	ECDIS		
21.2		Diving prohibited					Area where diving is prohibited	
22		Environmentally Sensitive Sea Areas					Environmentally Sensitive Sea Area (ESSA)	
		Seal sanctuary					Area with minor restrictions or information notices	
	<p>Note: Other animal silhouettes (e.g. seahorses, penguin, petrel) may be used, as appropriate.</p>							
		Non-specific nature reserve, National parks, Marine Reserves (MR)						
 <p style="font-size: small; margin-top: 5px;">Tint band may vary in width between 1–5 mm</p>	Particulary Sensitive Sea Area (PSSA)						PSSA	







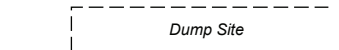



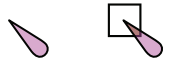











N Areas, Limits

No.	INT	Description	NOAA	NGA	Other NGA	ECDIS	
23.1	 Explosives Dumping Ground	Explosives dumping ground, individual mine or explosive					Explosives or chemical dumping ground as a point
23.2		Explosives dumping ground disused), Foul (explosives)					Explosives or chemical dumping ground as an area
24		Dumping ground for chemical waste					
25		Degaussing range (DG range)					Degaussing area
27	5kn	Maximum speed					If a speed restriction exists, the speed limit is obtained by cursor pick
Military Practice Areas							
30		Firing practice area					Restricted area
31		Military restricted area, entry prohibited					Area where entry is prohibited or restricted or to be avoided, with other cautions
32		Mine-laying (and counter-measures) practice area					Restricted area
33		Submarine transit lane and exercise area					
34		Minefield					Minefield
International Boundaries and National Limits						Supplementary national symbols: a, f, h	
40		International boundary on land					Jurisdiction boundary

No.	INT	Description	NOAA	NGA	Other NGA	ECDIS
41		International maritime boundary				Jurisdiction boundary
42		Straight territorial sea baseline with base point				Straight territorial sea baseline
43		Seaward limit of territorial sea				Territorial sea
44		Seaward limit of contiguous zone				Contiguous zone
45		Limits of fishery zones				Limits of fishery zone
46		Limit of continental shelf				Continental shelf area
47		Limit of Exclusive Economic Zone (EEZ)				Exclusive economic zone
48		Customs limit				Custom regulations zone
49		Harbor limit				Harbor area, symbolized
Various Limits						Supplementary national symbols: a, b
60.1		Limit of fast ice, Ice front (with date)				Continuous pattern for an ice area (glacier, etc.)
60.2		Limit of sea ice (pack ice) seasonal (with date)				
62.1		Spoil ground				HO information note
62.2		Spoil ground (disused)				
63		Extraction (dredging) area				Dredging area
64		Cargo transhipment area				HO information note
65		Incineration area				

N Areas, Limits

No.	INT	Description	NOAA	NGA	Other NGA	ECDIS
Supplementary National Symbols						
a		COLREGS demarcation line				
b		Limit of fishing area (fish trap areas)				
c		Dumping ground				
d		Dumping area (Dump site)				
f		Reservation line (Options)				
g		Dump site				
h		Three Nautical Mile Line				
i		No Discharge Zone				

No.	INT	Description	NOAA	NGA	Other NGA	ECDIS
Light Structures and Major Floating Lights						
Minor Light Floats → Q30, 31						
1.1	☆ ☆ Lt LtHo	Position of navigation light (size and style of "star" may vary) light, lighthouse		•	☆ ✧ ● •	 Light, lighthouse, paper chart
1.2		Light on standard charts				
1.3		Significant all-round light, generally for offshore navigation on multicolored charts				
2.1		Lighted offshore platform on standard charts	■ PLATFORM (lighted)			 Lighted offshore platform, paper chart
2.2	 	Lighted offshore platform on multicolored charts				
3	 	Lighted beacon tower	○ Marker (lighted)			 Lighted beacon tower, paper chart
4	  	Lighted beacon				 Lighted beacon, paper chart
5	 	Articulated light, buoyant beacon, resilient beacon				
Note: Minor lights, fixed and floating, usually conform to IALA Maritime Buoyage System characteristics.						
7	  	Navigational lights on landmarks or other structures				
8		Important light off chart limits				









P Lights

No.	Abbreviaton		Class of Light	Illustration	Period Shown	ECDIS	
	INT	NOAA					
Light Characters							
Light Characters on Light Buoys → Q							
10.1	F	F	Fixed			When text for lights is displayed, ECDIS uses INT abbreviations.	
Occulting (total duration of light longer than total duration of darkness)							
10.2	Oc	Oc	Single-occulting				
	Oc(2) Example	Oc (2)	Group-occulting				
	Oc(2+3) Example	Oc (2+3)	Composite group-occulting				
Isophase (duration of light and darkness equal)							
10.3	Iso	Iso	Isophase				
Flashing (total duration of light shorter than total duration of darkness)							
10.4	Fl	Fl	Single-flashing				
	Fl(3) Example	Fl (3)	Group-flashing				
	Fl(2+1) Example	Fl (2+1)	Composite group-flashing				
10.5	LFl	L Fl	Long-flashing flash 2s or longer)				
Quick (repetition rate of 50 to 79 - usually either 50 or 60 - flashes per minute)							
10.6	Q	Q	Continuous quick				
	Q(3) Example	Q (3)	Group quick				
	IQ	IQ	Interrupted quick				

No.	Abbreviaton		Class of Light	Illustration	Period Shown	ECDIS
	INT	NOAA				
Very quick (repetition rate of 80 to 159 - usually either 100 or 120 - flashes per minute)						
10.7	VQ	VQ	Continuous very quick			
	VQ(3) Example	VQ (3)	Group very quick			
	IVQ	IVQ	Interrupted very quick			
Ultra quick (repetition rate of 160 or more - usually 240 to 300 - flashes per minute)						
10.8	UQ	UQ	Continuous ultra quick			
	IUQ	IUQ	Interrupted ultra quick			
10.9	Mo(K) Example	Mo (K)	Morse code			
10.10	FFI	F FI	Fixed and flashing			
10.11	Al.WR	AlWR	Alternating			

When text for lights is displayed, ECDIS uses INT abbreviations.

P Lights

No.	INT	Description	NOAA	NGA	Other NGA	ECDIS	
Colors of Lights							
11.1	W	White (for lights, only on sector and alternating lights)				 Default light symbol if no color is encoded or color is other than red, green, white, yellow, amber, or orange  Red  Green  White, yellow, amber or orange  Sector lights	
11.2	R	Red					
11.3	G	Green					
11.4	Bu	Blue					
11.5	Vi	Violet					
11.6	Y	Yellow					
11.7	Y	Or	Orange				
11.8	Y	Am	Amber				
<p>Colors of lights shown on standard charts</p>  <p>on multicolored charts</p>  <p>on multicolored charts at sector lights</p> 							
Period							
12	2.5s	90s	Period in seconds and tenths of a second			<p>When text for lights is displayed, ECDIS uses INT abbreviations.</p>	
Elevation							
Plane of reference for Heights → H			Tidal Levels → H				
13	12m	Elevation of light given in meters or feet	36ft				
Range							
14	15M	Light with single range					
	15/10M	Light with two different ranges	10M <i>only lesser of two ranges is charted</i>		15/10M		
	15-7M	Light with three or more ranges	7M <i>only least of three ranges is charted</i>				
Note: Charted ranges are nominal ranges given in Nautical Miles.							
Disposition							
15	(hor)	Horizontally disposed				 Disposition of light is obtained by cursor pick	
	(vert)	Vertically disposed					
	(Δ) (∇)	3 lights disposed in the shape of a triangle					

No.	INT	Description	NOAA	NGA	Other NGA	ECDIS
Example of a Full Light Description						
16	INT Example ! Name ☆ FI(3)WRG.15s 21m 15-11M		NOAA Example ! Name • FI (3) WRG 15s 21ft 11M		NGA Example ! Name • FI (3) WRG 15s 21m 15-11M	FIR15s21m11M
	FI(3)	Class of light: group flashing repeating a group of three flashes	FI(3)	Class of light: group flashing repeating a group of three flashes		The descriptions of non-sector lights are shown in ECDIS when the display of text is turned on, as shown above. (The aid to navigation or other structure that is always shown attached to a light flare in ECDIS is not depicted here.) Sector lights (as described in the INT, NOAA and NGA examples at left) are depicted graphically in ECDIS, as shown below and in P40. The description of a sector light or any other type of light may always be obtained by cursor pick.
	WRG	Colors: white, red, green, exhibiting the different colors in defined sections	WRG	Colors: white, red, green, exhibiting the different colors in defined sections		
	15s	Period: the time taken to exhibit one full sequence of three flashes and eclipses: 15 seconds	15s	Period: the time taken to exhibit one full sequence of three flashes and eclipses: 15 seconds		
	21m	Elevation of focal plane above datum: 21 meters	21ft 21m	Elevation of light: 21 feet 21 meters		
15-11M	Nominal range: white 15M, green 11M, red between 15 and 11M	11M 15-11M	Nominal range: shortest range of all the lights is 11M white 15M, green 11M, red between 15 and 11M			
Lights Marking Fairways						
Leading Lights and Lights in Line						
20.1		Leading lights with leading line (solid line is the track to be followed) and arcs of visibility on standard charts Bearing given in degrees and tenths of a degree				Leading lights with sectors





P Lights

No.	INT	Description	NOAA	NGA	Other NGA	ECDIS
20.2		<p>Leading lights with leading line (solid line is the track to be followed) and arcs of visibility on multi-colored charts</p> <p>Bearing given in degrees and tenths of a degree</p>				
20.3		<p>Leading lights (≠ means lights in line) on standard charts</p> <p>Bearing given in degrees and tenths of a degree</p>				<p>Leading lights</p>
20.4		<p>Leading lights (≠ means lights in line) on multi-colored charts</p> <p>Bearing given in degrees and tenths of a degree</p>				
20.5		<p>Leading lights on small scale standard charts</p>				
20.6		<p>Leading lights on small scale multi-colored charts</p>				
21.1		<p>Lights in line, marking the sides of a channel on standard charts</p>				<p>Lights in line, marking the sides of a channel</p>
21.2		<p>Lights in line, marking the sides of a channel on multi-colored charts</p>				
22	Rear Lt or Upper Lt	Rear or upper light				
23	Front Lt or Lower Lt	Front or lower light				

No.	INT	Description	NOAA	NGA	Other NGA	ECDIS
Direction Lights						
30.1		Direction light with narrow sector and course to be followed, flanked by darkness or unintensified light				Directional light with sector
30.2		Direction light on standard charts with course to be followed, sector(s) uncharted				Directional light without sector
30.3		Direction light with narrow fairway sector flanked by light sectors of different character on standard charts				
30.4		Direction light with narrow fairway sector flanked by light sectors of different character on multicolored charts				
31		Moiré effect light (day and night), arrows show when course alteration needed				
Quoted bearings are always from seaward.						

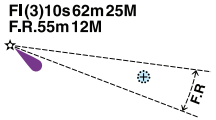

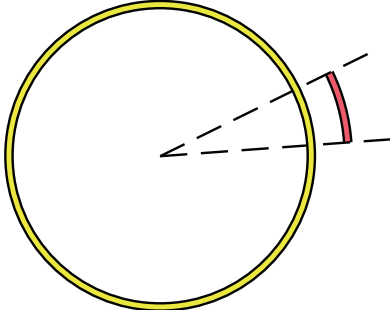
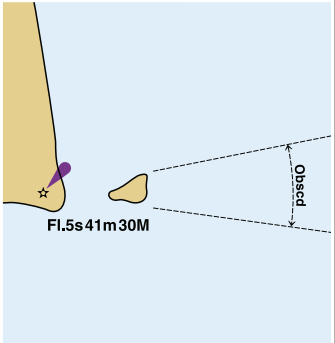

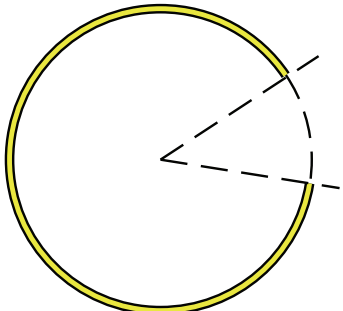
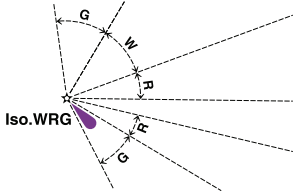
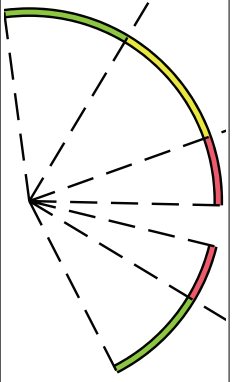







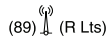
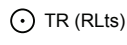

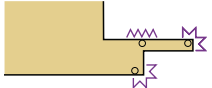
P Lights

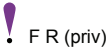
No.	INT	Description	NOAA	NGA	Other NGA	ECDIS
Sector Lights						
40.1		Sector light on standard charts				
40.2		Sector light on multicolored charts				
40.3		Sector light on standard charts. Sectors not charted				
40.4		Sector lights on multicolored charts. Sectors not charted				
41.1		Sector lights on standard charts, the white sector limits marking the sides of the fairway				
41.2		Sector lights on multicolored charts, the white sector limits marking the sides of the fairway				

No.	INT	Description	NOAA	NGA	Other NGA	ECDIS
42.1	 <p>Fl(3)10s62m25M F.R.55m12M</p>	Main light visible all-round with red subsidiary light seen over danger				<p>Light, danger</p> 
43.1	 <p>Fl.5s41m30M</p>	All-round light with obscured sector				<p>Light, obscured</p> 
44.1	 <p>Iso.WRG</p>	Light with arc of visibility deliberately restricted				 <p>Light, restricted</p>

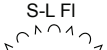
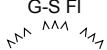
P Lights





















No.	INT	Description	NOAA	NGA	Other NGA	ECDIS	
45.1		Light with faint sector					Light, faint
46.1		Light with intensified sector					Intensified light visibility is obtained by cursor pick
							Light, intensified
Lights with Limited Times of Exhibition							
50		Lights exhibited only when specially needed (for fishing vessels, ferries) and some private lights	Occas				Status and condition of light is obtained by cursor pick
51		Daytime light (charted only where the character shown by day differs from that shown at night)					
52		Fog light (exhibited only in fog, or character changes in fog)					
53		Unwatched (unmanned) light with no standby or emergency arrangements					
54	(temp)	Temporary					
55	exting)	Extinguished					
56	(man)	Manually activated					
Special Lights							
Flare Stack (as sea) → L		Flare Stack (on land) → E		Signal Stations → T			
60		Aero light (may be unreliable)					Light

No.	INT	Description	NOAA	NGA	Other NGA	ECDIS	
61.1		Air obstruction light of high intensity (e.g. on radio mast)					Conspicuous mast with light
61.2		Air obstruction light of low intensity (e.g. on radio mast)					
62	Fog Det Lt	Fog detector light					Category of light is obtained by cursor pick
63	 Illuminated)	Floodlit, floodlighting of a structure					Floodlight
64		Strip light					Strip light
On multicolored charts, P63 and P64 may be any appropriate color.							
65	(priv)	Private light other than one exhibited occasionally					Status of private is obtained by cursor pick
66	(sync)	Synchronized light					
Supplementary National Symbols							
a		Riprap surrounding light					
b		Short-Long Flashing					
c		Group-Short Flashing					
d		Fixed and Group Flashing					
e		Unmanned light-vessel; light float					
f		LANBY, superbuoy as navigational aid					



















Simplified and Traditional Paper Chart Symbols

ECDIS can be set to display aids to navigation with either traditional paper chart or simplified symbols. The two symbol sets are shown below. Some ECDIS color fill the paper chart buoy shapes, but this is not required by IHO ECDIS portrayal specifications.

Floating Marks

Paper Chart	Simplified	Simplified Symbol Name
* ▲		Cardinal buoy, north
* ◆		Cardinal buoy, east
* ▼		Cardinal buoy, south
* ⬇		Cardinal buoy, west
⊙?		Default symbol for buoy (used when no defining attributes have been encoded in the ENC)
* ●		Isolated danger buoy
		Conical lateral buoy, green
		Conical lateral buoy, red
		Can shape lateral buoy, green
		Can shape lateral buoy, red
		Installation buoy and mooring buoy
		
		
**		Safe water buoy
		Special purpose buoy, spherical or barrel shaped, or default symbol for special purpose buoy
		Special purpose TSS buoy marking the starboard side of the traffic lane
		Special purpose TSS buoy marking the port side of the traffic lane
		Special purpose ice buoy or spar or pillar shaped buoy
		Super-buoy ODAS & LANBY
		Light float
		Light vessel









Fixed Marks

















Paper Chart	Simplified	Simplified Symbol Name
* ▲		Cardinal beacon, north
* ◆		Cardinal beacon, east
* ▼		Cardinal beacon, south
* ⬇		Cardinal beacon, west
		Default symbol for a beacon (used when no defining attributes have been encoded in the ENC)
		Isolated danger beacon
		Major lateral beacon, red
		Major lateral beacon, green
		Minor lateral beacon, green
		Major safe water beacon
		Minor safe water beacon
		Major special purpose beacon
		Minor special purpose beacon

* Paper chart symbols display various buoy or beacon shape symbols in conjunction with the topmark. Simplified portrayal only displays the topmark.



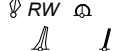







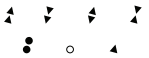























































** Several different paper chart symbols correspond to this simplified symbol.































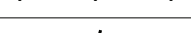







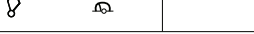



Day Marks

Paper Chart	Simplified	Simplified Symbol Name
		Square or rectangular daymark
		Triangular daymark, point up
		Triangular daymark, point down
		Retro reflector

No.	INT	Description	NOAA	NGA	Other NGA	ECDIS
Buoys and Beacons						
IALA Maritime Buoyage System, which includes Beacons → Q 130						
		Default buoy symbol if no other defining attribution is provided				 Default symbol for buoy, paper chart
		Default buoy symbol if no other defining attribution is provided				 Default symbol for buoy, simplified
		Default beacon symbol if no other defining attribution is provided				 Default symbol for a beacon, paper chart
		Default beacon symbol if no other defining attribution is provided				 Default symbol for a beacon, simplified
1		Position of buoy or beacon	°			ECDIS shows the position of buoys and beacons with a circle at the bottom of paper chart symbols. For simplified symbols, the position of the aid corresponds with the center of the symbol.
Colors of Buoys and Beacon Topmarks						Supplementary national symbols: p
Abbreviations for Colors → P						
2		Green and black (symbols filled black)				
3		Single color other than green and black				
4		Multiple colors in horizontal bands, the color sequence is from top to bottom				
5		Multiple colors in vertical or diagonal stripes, the darker color is given first				
6		Retroreflecting material				
Lighted Marks						Supplementary national symbols: p
Marks with Fog Signals → R						
7		Lighted marks on standard charts				
8		Lighted marks on multicolored charts				
Note: On standard charts, the light flares of buoys and beacons are shown in magenta. On multicolored charts, the light flares are shown in the colors of the appropriate light						

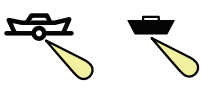
Q Buoys, Beacons

No.	INT	Description	NOAA	NGA	Other NGA	ECDIS																																													
Topmarks and Radar Reflectors																																																			
For Application of Topmarks within the IALA System → Q 130			For other topmarks (special purpose buoys and beacons) → Q																																																
9		IALA System buoy topmarks beacon topmarks shown upright)				<p>Paper chart symbols for topmarks (on the left, below) are always displayed above a buoy or beacon shape symbol, as in Q 10 and Q 11.</p> <p>Simplified symbols (on the right, below) for cardinal marks, isolated dangers and safe water consist of only the topmark without the buoy shape symbol.</p> <p>Simplified symbology for marks with any other type of topmark will display only the simplified buoy or beacon shape symbol without a topmark.</p> <table border="1"> <tr> <td></td> <td></td> <td>2 cones point upward</td> </tr> <tr> <td></td> <td></td> <td>2 cones point downward</td> </tr> <tr> <td></td> <td></td> <td>2 cones base to base</td> </tr> <tr> <td></td> <td></td> <td>2 cones point to point</td> </tr> <tr> <td></td> <td></td> <td>2 spheres</td> </tr> <tr> <td></td> <td></td> <td>Sphere</td> </tr> <tr> <td></td> <td></td> <td>Cone point up</td> </tr> <tr> <td></td> <td></td> <td>Cone point down</td> </tr> <tr> <td></td> <td></td> <td>Cylinder, square, vertical rectangle</td> </tr> <tr> <td></td> <td></td> <td>X-shape</td> </tr> <tr> <td></td> <td></td> <td>Flag or other shape</td> </tr> <tr> <td></td> <td></td> <td>Board, horizontal rectangle</td> </tr> <tr> <td></td> <td></td> <td>Cube point up</td> </tr> <tr> <td></td> <td></td> <td>Upright cross over a circle</td> </tr> <tr> <td></td> <td></td> <td>T-shape</td> </tr> </table>			2 cones point upward			2 cones point downward			2 cones base to base			2 cones point to point			2 spheres			Sphere			Cone point up			Cone point down			Cylinder, square, vertical rectangle			X-shape			Flag or other shape			Board, horizontal rectangle			Cube point up			Upright cross over a circle			T-shape
		2 cones point upward																																																	
		2 cones point downward																																																	
		2 cones base to base																																																	
		2 cones point to point																																																	
		2 spheres																																																	
		Sphere																																																	
		Cone point up																																																	
		Cone point down																																																	
		Cylinder, square, vertical rectangle																																																	
		X-shape																																																	
		Flag or other shape																																																	
		Board, horizontal rectangle																																																	
		Cube point up																																																	
		Upright cross over a circle																																																	
		T-shape																																																	
10		Beacon with topmark, color, radar reflector and designation																																																	



















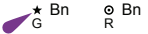







No.	INT	Description	NOAA	NGA	Other NGA	ECDIS		
11	 No 3	Buoy with topmark, color, radar reflector and designation	 G N "3"	 No 3		by No 3 	Conical buoy with topmark, paper chart	
Note: Radar reflectors on floating marks usually are not charted. ECDIS does not display radar reflectors on fixed or floating aids; this information is obtained by cursor pick.								
Buoys								
Shapes of Buoys								
Features Common to Buoys and Beacons → Q 1–11								
						Paper Chart	Simplified	
20		Conical buoy, nun buoy, ogival buoy						Conical buoy
21		Can buoy or cylindrical buoy						Can buoy
22		Spherical buoy						Spherical buoy
23		Pillar buoy; Buoy with no distinctive shape						Pillar buoy
24		Spar buoy, spindle buoy						Spar buoy
25		Barrel buoy, tun buoy						Barrel buoy
26		Superbuoy						Super-buoy Lanby, super-buoy Super-buoy odas & lanby
Light Vessels and Minor Light Floats								
30.1	 <i>FIG.3s</i> Name	Light float on standard charts						Light float
30.2	 <i>FIG.3s</i> Name	Light float on multi-colored charts						
31	 <i>Fl.10s</i> †	Light float not part of IALA System						Light float
32		Light vessel						Light vessel, paper chart























Q Buoys, Beacons

No.	INT	Description	NOAA	NGA	Other NGA	ECDIS
Mooring Buoys						
Oil or Gas Installation Buoy → L						
40		Mooring buoys				<p>Mooring buoy, can shape, paper chart</p> <p>Mooring buoy, barrel shape, paper chart</p> <p>Installation buoy and mooring buoy, simplified</p>
41.1		Lighted mooring buoy (example) on standard charts				
41.2		Lighted mooring buoy (example) on multi-colored charts				
42		Trot, mooring buoys with ground tackle and berth numbers				<p>Trot, mooring buoys with ground tackle and berth numbers</p>
43		Mooring buoy with telephonic communication		<p>Tel = telegraphic</p> <p>T = telephonic</p>		<p>Mooring buoy, can shape, paper chart</p> <p>Mooring buoy, barrel shape, paper chart</p> <p>Installation buoy and mooring buoy, simplified</p>
44		Numerous moorings (example)				<p>Small-craft mooring area</p>
45		Visitors' mooring				<p>Availability of visitor mooring at marina is obtained by cursor pick</p>

No.	INT	Description	NOAA	NGA	Other NGA	ECDIS	
Special Purpose Buoys							
Note: Shapes of buoys are variable. Lateral or Cardinal buoys may be used in some situations.							
						Purpose of buoy and other information is obtained by cursor pick	
Purpose of buoy may be shown by label.							
50	DZ	Firing danger area (Danger Zone) buoy					Conical buoy with topmark, paper chart
54	DG	Degaussing Range buoy					Special purpose buoy, spherical or barrel shaped, or default symbol for special purpose buoy, simplified
58	ODAS ODAS	ODAS buoy (Ocean Data Acquisition System), data collecting buoy	ODAS ODAS			 	Super-buoy, paper chart Super-buoy odas & lanby, simplified Spherical buoy, paper chart Spherical buoy, simplified







Q Buoy, Beacons

No.	INT	Description	NOAA	NGA	Other NGA	ECDIS
70		Buoy privately maintained (example)			 (<i>occas</i>)  (<i>01.04.-31.10.</i>)	 Status as private is obtained by cursor pick
71		Seasonal buoy (example)				 Status as periodic and period start and stop dates are obtained by cursor pick
Beacons						
Lighted Beacons → P		Features Common to Beacons and Buoys → Q1–11				
80		Beacon in general, characteristics unknown or chart scale too small to show	 Bn			 Default symbol for a beacon, paper chart  Default symbol for a beacon, simplified  Beacon in general, paper chart
81		Beacon with color, no distinctive topmark	 R  G  RW  Bn			 Beacon color is obtained by cursor pick
82		Beacons with colors and topmarks (examples)				 Beacon color is obtained by cursor pick See note at Q 9 for information about topmarks and ECDIS simplified symbology  Beacon in general with topmark, paper chart  Major red lateral beacon, simplified  Beacon in general with topmark, paper chart  Cardinal beacon, north, simplified  Beacon in general with topmark, paper chart  Isolated danger beacon, simplified

No.	INT	Description	NOAA	NGA	Other NGA	ECDIS	
83		Beacon on submerged rock with colors (topmark as appropriate)					Beacon in general with topmark, paper chart Isolated danger beacon, simplified
Minor Impermanent Marks Usually in Drying Areas (Lateral Marks of Minor Channels)							
Minor Pile → F							
90		Stake, pole	† ○ Stake † ○ Pole	● Stake ● Pole			Minor, stake or pole beacon, paper chart
91	Port Hand 	Starboard Hand 	Perch, withy				Minor, stake or pole beacon, paper chart
		Minor red lateral beacon, simplified					
92			Withy				Minor green lateral beacon, simplified
Minor Marks, Usually on Land							
Landmarks → E							
100		Cairn	○ Cairn	⊙ CAIRN			Conspicuous cairn
101		Colored or white mark					Square or rectangular day mark, paper chart
							Square or rectangular day mark, simplified
							Triangular day mark, point up, paper chart
							Triangular day mark, point up, simplified
							Triangular day mark, point down, paper chart
							Triangular day mark, point down, simplified

IALA Maritime Buoyage System

IALA International Association of Marine Aids to Navigation and Lighthouse Authorities

Where in force, the IALA System applies to all fixed and floating marks except landfall lights, leading lights and marks, sectored lights and major floating lights. The standard buoy shapes are: cylindrical (can) , conical , spherical , pillar , and spar , but variations may occur, for example: minor light floats .

130

There are two international buoyage regions where lateral marks differ. Each region is primarily comprised of the waters surrounding the areas shown below.

Region A: Greenland, Africa, Europe, Australia and Asia (except for Japan, the Republic of Korea, Taiwan and the Philippines).

Region B: North and South America, Japan, the Republic of Korea, Taiwan and the Philippines.

ECDIS marks the boundary between IALA regions A and B with this symbol: 

130.1

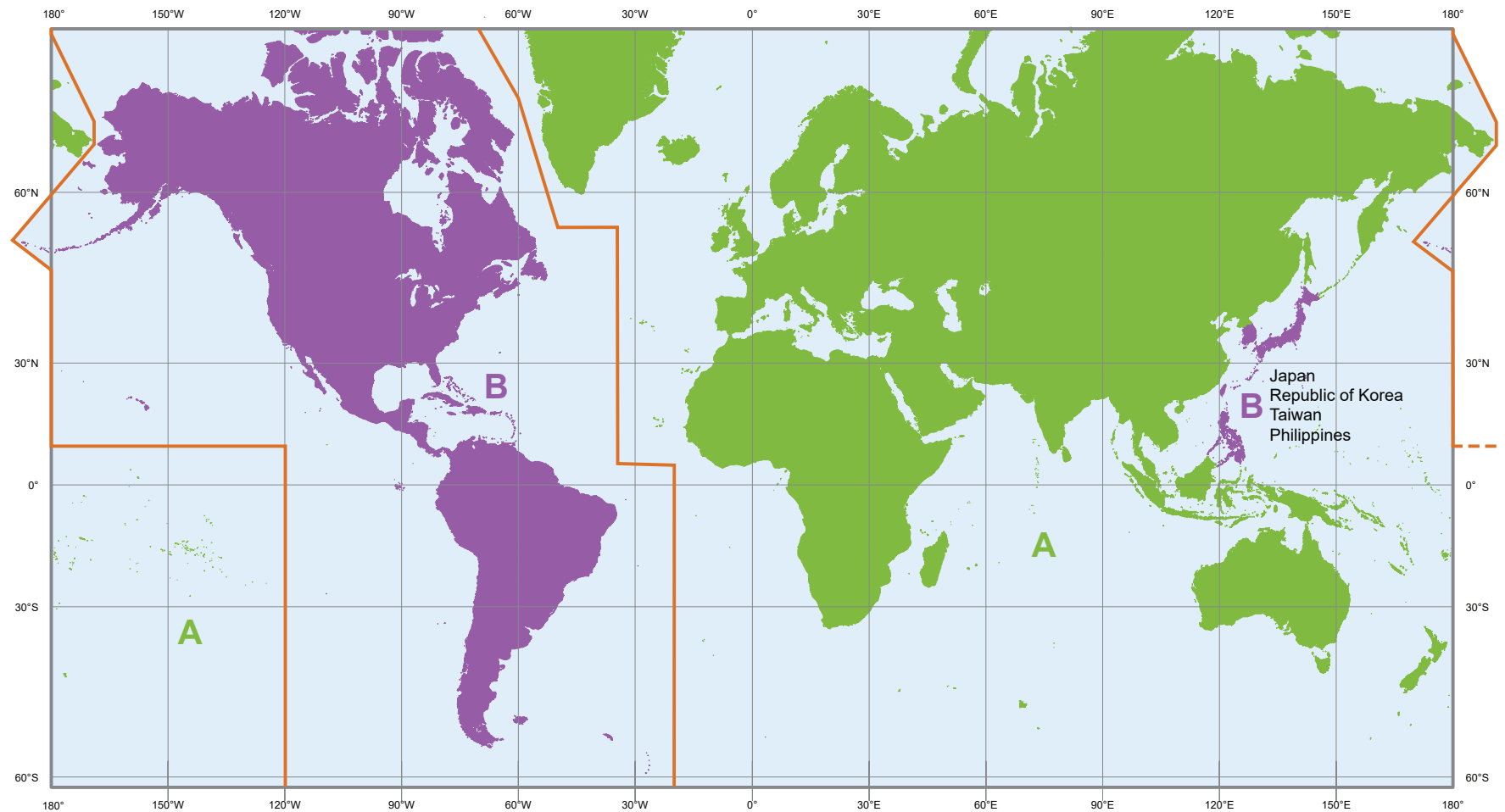

Q Buoys, Beacons

Lateral Marks are generally for well-defined channels. There are two international buoyage regions—A and B—where lateral marks differ by color, but not by shape or topmark.







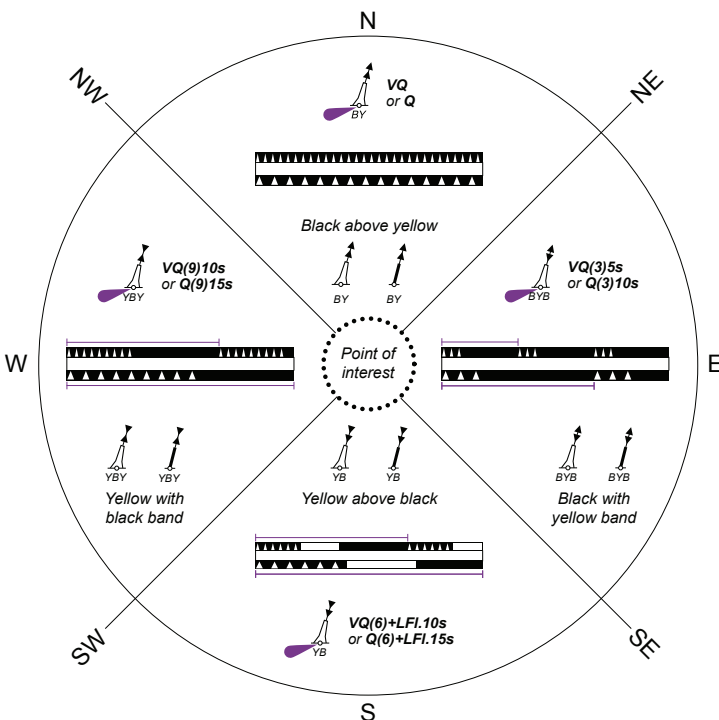
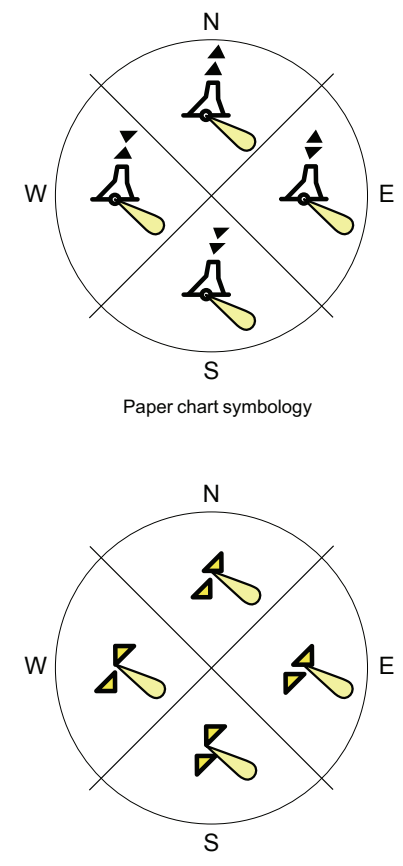











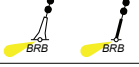











130.1	INT	<p>Port-hand marks are red with cylindrical topmarks (if any). If lit, light is red.</p> <p>Starboard-hand marks are green with conical topmarks (if any). If lit, light is green.</p> <p>REGION A</p>	<p>Port-hand marks are green with cylindrical topmarks (if any). If lit, light is green.</p> <p>Starboard-hand marks are red with conical topmarks (if any). If lit, light is red.</p> <p>REGION B</p>	<p>Buoy shape may be cylindrical or conical (to indicate port or starboard) but may be another shape with appropriate topmark. Marks which indicate a junction with a side channel have three horizontal color bands and, if lit, the rhythm will be FI(2+1).</p> <p>Buoys in U.S. waters generally do not have topmarks.</p>
	NOAA	<p>Port-hand marks are red with cylindrical topmarks (if any). If lit, light is red.</p> <p>Starboard-hand marks are green with conical topmarks (if any). If lit, light is green.</p> <p>REGION A</p>	<p>Port-hand marks are green with cylindrical topmarks (if any). If lit, light is green.</p> <p>Starboard-hand marks are red with conical topmarks (if any). If lit, light is red.</p> <p>REGION B</p>	











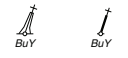

























Direction of Buoyage: The direction of buoyage is that taken when approaching a harbor from seaward. Along coasts, the direction is determined by buoyage authorities, normally clockwise around land masses.

130.2	INT	Symbols showing direction of buoyage where it is not obvious		
	ECDIS	<p>General symbol for direction of buoyage</p>	<p>IALA Region A on multicolored charts</p>	<p>IALA Region B on multicolored charts</p>
		<p>General symbol for direction of buoyage</p>	<p>IALA Region A</p>	<p>IALA Region B</p>



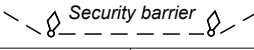



















No.	INT	ECDIS
130.3	<p>Cardinal Marks: indicating navigable water to the named side of the marks. In the illustration below all marks are the same in Regions A and B.</p>  <p>Topmark: 2 black cones Light: White</p> <p>The same abbreviations are used for lights on spar buoys and beacons.</p> <p>The periods 5s, 10s, and 15s may not always be charted.</p> <p>Time (seconds) 0 5 10 15 Period shown</p> <p>Cardinal marks are seldom used in U.S. waters and do not appear on NOAA charts, except for charts that also depict Canadian waters.</p>	 <p>Paper chart symbology</p> <p>Simplified symbology</p>



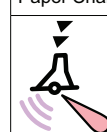
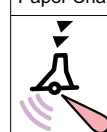

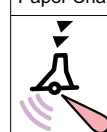

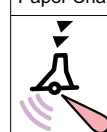













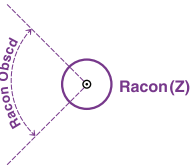

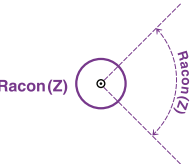
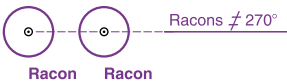

Q Buoy, Beacons

No.	INT	Description	NOAA	NGA	Other NGA	ECDIS	
124	 Ref	Refuge beacon					Purpose as refuge or firing danger area beacon is obtained by cursor pick
126		Notice board					Notice board
130.4	Isolated Danger Marks stationed over dangers with navigable water around them. Body: black with red horizontal band(s) Topmark: two black spheres Light: white						
		Unlit Marks					Pillar buoy with 2 spheres topmark
		Lighted Marks on standard charts					Spar buoy with 2 spheres topmark
		Unlit Marks on multicolored charts					Isolated danger buoy, simplified
130.5	Safe Water Marks , including mid-channel and landfall marks. Body: red and white vertical stripes Topmark (if any): red sphere Light: white						
		Unlit marks					Spherical buoy, paper chart
		Lighted Marks on standard charts					Pillar buoy with sphere topmark
		Lighted Marks on multicolored charts					Spar buoy with sphere topmark
							Safe water buoy, simplified
130.6	Special Marks not primarily to assist navigation but to indicate special features. Body (shape optional): yellow* Topmark (if any): yellow X or upright cross Light: yellow, rhythm optional*						
		Unlit Marks					Spherical buoy, paper chart
		Lighted Marks on standard charts					Can buoy
		Lighted Marks on multicolored charts					Conical buoy
							Spar buoy with x-shape topmark
							Special purpose buoy, simplified
* In special cases, yellow may be used in conjunction with another color							

No.	INT	Description	NOAA	NGA	Other NGA	ECDIS
130.7	New Danger Marks. Body (shape optional): yellow and blue Topmark: yellow cross					
	  	Unlit marks Lighted Marks on standard charts Lighted Marks on multicolored charts				 
Supplementary National Symbols						
a		Bell buoy	 BELL	 BELL		
b		Gong buoy	 GONG	 GONG		
c		Whistle buoy	 WHIS	 WHIS		
d		Fairway buoy (red and white vertical stripe)	 RW			
e		Mid-channel buoy (red and white vertical stripe)	 RW			
f		Starboard-hand buoy (entering from seaward - US waters)	 R "2"			
g		Port-hand buoy (entering from seaward - US waters)	 G "1"  "1"			
h		Bifurcation/Junction buoys	 RG  GR			
		Isolated danger, Wreck or Obstruction buoy	 BR			
i		Fish trap (area) buoy	 Y			
j		Anchorage buoy (marks limits)	 Y			
l		Triangular shaped beacons	 R  RG Bn			
		Square shaped beacons	 G  GR Bn  W Bn  B Bn			
		Beacon, color unknown	 Bn			
o		Lighted beacon	 !	 !	 ! Bn  !	
q		Security barrier	 Security barrier			
r		Scientific mooring buoy				
s		Float (unlighted)				
t		White and blue buoy		 WBW		















R Fog Signals

No.	INT	Description	NOAA	NGA	Other NGA	ECDIS					
General											
Fog Detector Light → P		Fog Light → P									
1		Position of fog signal, type of fog signal not stated	Fog Sig 				Position of a conspicuous point feature with fog signal Lighted pillar buoy, paper chart with fog signal Lighted super-buoy, paper chart with fog signal				
2	(man)	Manually activated									
Types of Fog Signals, with Abbreviations						Supplementary national symbol: a					
10	Explos	Explosive		<i>GUN</i>		 Type of fog signal and its characteristics are obtained by cursor pick					
11	Dia	Diaphone		<i>DIA</i>							
12	Siren	Siren		<i>SIREN</i>							
13	Horn	Horn (nautophone, reed, tyfon)		<i>HORN</i>							
14	Bell	Bell		<i>BELL</i>							
15	Whis	Whistle		<i>WHISTLE</i>							
16	Gong	Gong		<i>GONG</i>							
Examples of Fog Signal Descriptions											
Note: The fog signal symbol will usually be omitted when a description of the signal is given.											
20	 <i>Fl.3s70m29M Siren Mo(N)60s</i>	Siren at a lighthouse, giving a long blast followed by a short one (N), repeated every 60 seconds	 <i>Fl 3s 70m 29M SIREN Mo(N) 60s</i>	 <i>Fl 3s 70m 29M SIREN</i>			Light with fog signal				
21	 <i>Bell</i>	Wave-actuated bell buoy	 <i>BELL</i>	 <i>BELL</i>			Pillar buoy, paper chart with fog signal				
22	 <i>Q(6)+LFl.15s Horn(1)15sWhis</i>	Light buoy, with horn giving a single blast every 15 seconds, in conjunction with a wave-actuated whistle	 <i>Q(6)+LFl 15s HORN(1) 15s WHIS</i>	 <i>Q(6)+LFl 15s HORN WHIS</i>			<table border="1"> <tr> <td>Paper Chart</td> <td>Simplified</td> </tr> <tr> <td></td> <td></td> </tr> </table> Lighted pillar buoy, paper chart with fog signal	Paper Chart	Simplified		
Paper Chart	Simplified										
											
Supplementary National Symbol											
a		Morse Code fog signal		<i>Mo</i>							

No.	INT	Description	NOAA	NGA	Other NGA	ECDIS		
Radar								
Radar Structures Forming Landmarks → E			Radar Surveillance Systems → M					
1	 Ra	Coast radar station, providing range and bearing service on request		 Ra			Radio station	
2	 Ramark	Ramark, radar beacon transmitting continuously		 Ramark				
3.1	 Racon(Z)(3cm)	Radar transponder beacon, with morse identification, responding within the 3 cm (X) band	†	 RACON				
3.2	 Racon(Z)(10cm)	Radar transponder beacon, with morse identification, responding within the 10 cm (S) band	†					
3.3	 Racon(Z)	Radar transponder beacon, with morse identification			 Racon(Z) (3 & 10 cm)			
3.4		Radar transponder beacon with sector of obscured reception					Radar transponder beacon	
		Radar transponder beacon with sector of reception						
3.5		Leading radar transponder beacons (±: objects in line)						
		Leading radar transponder beacons coincident with leading lights						
3.6	 Racon  Racon	Radar transponder beacons on floating marks	 RACON (-) R "Z" Fl R 4s	 Racon		Paper Chart 	Simplified 	Radar transponder on floating mark
4		Radar reflector		 			Symbol indicating this object is radar conspicuous	
Radar reflectors are not charted on buoys in regions where they are fitted to nearly all buoys								
5		Radar conspicuous feature						









S Radar, Radio, Satellite Navigation Systems

No.	INT	Description	NOAA	NGA	Other NGA	ECDIS
Radio						
Radio Structures Forming Landmarks → E		Radio Reporting (Calling-in or Way) points → M				
10		Circular (non-directional) marine or aeromarine radiobeacon				 Radio station Additional information regarding radio, such as category of radio station, signal frequency, communication channel, call sign, estimated signal range, periodicity and status may be included in the cursor pick. The presence of an AIS transmitted signal intended for use as an aid to navigation associated with a physical aid, including the AIS MMSI Number, can be obtained by cursor pick on the physical aid.
11		Directional radiobeacon with bearing line				
		Directional radiobeacon coincident with leading lights				
12		Rotating pattern radiobeacon				
13		Consol beacon				
14		Radio direction-finding station				
15		Coast radio station providing QTG service				
16		Aeronautical radiobeacon				
17.1		Automatic Identification System transmitter				
17.2		Automatic Identification System transmitter on floating marks (examples)				
18.1		Virtual AIS (with unknown IALA-defined function)				
18.2		Virtual AIS (with known IALA-defined function)				 North cardinal virtual aid East cardinal virtual aid South cardinal virtual aid West cardinal virtual aid

No.	INT	Description	NOAA	NGA	Other NGA	ECDIS	
18.3	 V-AIS	Virtual AIS with lateral mark function				 V-AIS	Port Lateral (IALA B) virtual aid
	 V-AIS					 V-AIS	Starboard Lateral (IALA B) virtual aid
18.4	 V-AIS	Virtual AIS with isolated danger mark function				 V-AIS	Isolated Danger virtual aid
18.5	 V-AIS	Virtual AIS with safe water mark function				 V-AIS	Safe Water virtual aid
18.6	 V-AIS	Virtual AIS with special purpose mark function				 V-AIS	Special Purpose virtual aid
18.7	 V-AIS	Virtual AIS with new danger mark function				 V-AIS	Emergency Wreck virtual aid
Satellite Navigation Systems							
50	WGS WGS72 WGS84	World Geodetic System, 1972 or 1984					
	Note: A note may be shown to indicate the shifts of latitude and longitude, to one, two or three decimal places of a minute, depending on the chart scale, which should be made to satellite-derived positions (which are referred to WGS 84) to relate them to the chart.						
51	 DGPS	Station providing DGPS corrections				 DGPS	DGPS reference station

T Services

No.	INT	Description	NOAA	NGA	Other NGA	ECDIS
Pilotage						
1.1		Boarding place, position of a pilot cruising vessel	<i>Pilots</i>			Pilot boarding place
1.2	<i>Name</i>	Boarding place, position of a pilot cruising vessel, with name (e.g. District, Port)		<i>Name</i>		
1.3	<i>Note</i>	Boarding place, position of a pilot cruising vessel, with note (e.g. Tanker, Disembarkation)		(see note)		
1.4	<i>H</i>	Pilots transferred by helicopter				
2	■ Pilot Lookout	Pilot office with pilot lookout, Pilot lookout station				
3	■ Pilots	Pilot office	PIL STA	■ Pilots		
4	Port name (Pilots)	Port with pilotage service (boarding place not shown)				
Coast Guard, Rescue						
10	■ CG ○ CG	Coast Guard station	CG			CG
			R TR CG WALLIS SANDS			
11	■ CG	Coast Guard station with Rescue station				CG
12		Rescue station, Lifeboat station, Rocket station	LS S			
13		Lifeboat lying at a mooring				
14	Ref	Refuge for shipwrecked mariners				
	<i>Ref</i>					
Signal Stations						
20		Signal station in general		Sig Sta		
21	<i>SS (INT)</i>	Signal station, showing international port traffic signals				
22	<i>SS (Traffic)</i>	Traffic signal station, Port entry and departure signals				
23	<i>SS (Port Control)</i>	Port control signal station	HECP			

No.	INT	Description	NOAA	NGA	Other NGA	ECDIS			
24	 SS (Lock)	Lock signal station				 Signal station			
25.1	 SS (Bridge)	Bridge passage signal station							
25.2	†  F Traffic-Sig	Bridge lights including traffic signals							
28	○ SS (Storm)	Storm signal station		S Sig Sta					
29	○ SS (Weather)	Weather signal station, Wind signal station, National Weather Service (NWS) signal station							
30	○ SS (Ice)	Ice signal station							
31	○ SS (Time)	Time signal station							
32.1		Tide scale or gauge		○ Tide Gauge					
32.2	○ Tide Gauge	Automatically recording tide gauge							
33	○ SS (Tide)	Tide signal station							
34	○ SS (Stream)	Tidal stream signal station							
35	○ SS (Danger)	Danger signal station							
36	○ SS (Firing)	Firing practice signal station							
Supplementary National Symbols									
a		Bell (on land)	○ BELL						
b		Marine police station	○ MARINE POLICE						
c		Fireboat station	○ FIREBOAT STATION						
d		Notice board							
e		Lookout station; Watch tower		 LOOK TR					
f		Semaphore		Sem					
g		Park Ranger station							

U Small Craft (Leisure) Facilities

No.	INT	Description	NOAA	NGA	Other NGA	ECDIS																																																																																																																																																																																																			
Small Craft (Leisure) Facilities																																																																																																																																																																																																									
Traffic Features, Bridges → D		Public Buildings, Cranes → F		Pilots, Coast Guard, Rescue, Signal Stations → T																																																																																																																																																																																																					
a	Marina facilities																																																																																																																																																																																																								
	<table border="1"> <thead> <tr> <th rowspan="2">NO</th> <th rowspan="2">LOCATION</th> <th>TIDES</th> <th>DEPTH</th> <th colspan="6">SERVICES</th> <th colspan="10">SUPPLIES</th> </tr> <tr> <th>APPROACH-FEET (REPORTED)</th> <th>ALONGSIDE-FEET (REPORTED)</th> <th>RAMP SURFACED-NATURAL</th> <th>ELECTRICITY-MOORINGS-BERTHS</th> <th>REPAIRS HULL-MOTOR-RADIO</th> <th>MARINE RAILWAY-FEET</th> <th>LIFT CAPACITY-TONS</th> <th>BOAT RENTAL</th> <th>CANOE-ROW-MOTOR</th> <th>FOOD-LODGING-CAMPING</th> <th>CHARTER-HOUSE-SAIL</th> <th>PUMP OUT STATION</th> <th>WINTER STORAGE-LAUNDRY</th> <th>NAUTICAL CHART SALES</th> <th>WATER-ICE</th> <th>GROCERIES-HARDWARE</th> <th>BAIT-TACKLE</th> <th>DIESEL OIL-GASOLINE</th> </tr> </thead> <tbody> <tr> <td>1</td> <td>LAS VEGAS BOAT</td> <td></td> <td></td> <td>80</td> <td>20</td> <td></td> <td>S</td> <td>HM</td> <td></td> <td></td> <td></td> <td>M</td> <td></td> <td></td> <td>F C</td> <td>T P</td> <td>WD</td> <td>C</td> <td>WI</td> <td>GH</td> <td>BT</td> <td>G</td> </tr> <tr> <td>2</td> <td>LAKE MEAD MAR</td> <td></td> <td></td> <td>80</td> <td>15</td> <td>B E</td> <td>S</td> <td>HM</td> <td></td> <td></td> <td></td> <td>M</td> <td></td> <td></td> <td>FL</td> <td>T P</td> <td>WD</td> <td>C</td> <td>WI</td> <td></td> <td></td> <td>DG</td> </tr> <tr> <td>3</td> <td>HEMENWAY HARBOR</td> <td></td> <td></td> <td>80</td> <td></td> <td></td> <td>S</td> <td></td> <td></td> <td></td> <td></td> <td></td> <td></td> <td></td> <td></td> <td></td> <td></td> <td></td> <td></td> <td></td> <td></td> <td></td> </tr> <tr> <td>4</td> <td>TEMPLE BAR HAR</td> <td></td> <td></td> <td>80</td> <td>15</td> <td></td> <td>SN</td> <td></td> <td></td> <td></td> <td></td> <td>M</td> <td>H</td> <td>FLC</td> <td>TSL P</td> <td>WD</td> <td>C</td> <td>WI</td> <td>GH</td> <td>BT</td> <td>G</td> </tr> <tr> <td>5</td> <td>ECHO BAY RESORT</td> <td></td> <td></td> <td>35</td> <td>35</td> <td>BM</td> <td>S</td> <td>M</td> <td></td> <td></td> <td></td> <td>M</td> <td>H</td> <td>FLC</td> <td>TSL P</td> <td>WD</td> <td>C</td> <td>WI</td> <td>GH</td> <td>BT</td> <td>G</td> </tr> <tr> <td>6</td> <td>OVERTON BEACH</td> <td></td> <td></td> <td>100</td> <td></td> <td></td> <td>S</td> <td></td> <td></td> <td></td> <td></td> <td>M</td> <td></td> <td>F C</td> <td>TSL</td> <td>WD</td> <td></td> <td>WI</td> <td>G</td> <td>BT</td> <td>G</td> </tr> <tr> <td>7</td> <td>CALLVILLE BAY M</td> <td></td> <td></td> <td>100</td> <td>40</td> <td></td> <td>S</td> <td></td> <td></td> <td></td> <td></td> <td>M</td> <td>H</td> <td>F C</td> <td>TS P</td> <td>WD</td> <td></td> <td>WI</td> <td>G</td> <td>B</td> <td>G</td> </tr> </tbody> </table>						NO	LOCATION	TIDES	DEPTH	SERVICES						SUPPLIES										APPROACH-FEET (REPORTED)	ALONGSIDE-FEET (REPORTED)	RAMP SURFACED-NATURAL	ELECTRICITY-MOORINGS-BERTHS	REPAIRS HULL-MOTOR-RADIO	MARINE RAILWAY-FEET	LIFT CAPACITY-TONS	BOAT RENTAL	CANOE-ROW-MOTOR	FOOD-LODGING-CAMPING	CHARTER-HOUSE-SAIL	PUMP OUT STATION	WINTER STORAGE-LAUNDRY	NAUTICAL CHART SALES	WATER-ICE	GROCERIES-HARDWARE	BAIT-TACKLE	DIESEL OIL-GASOLINE	1	LAS VEGAS BOAT			80	20		S	HM				M			F C	T P	WD	C	WI	GH	BT	G	2	LAKE MEAD MAR			80	15	B E	S	HM				M			FL	T P	WD	C	WI			DG	3	HEMENWAY HARBOR			80			S																4	TEMPLE BAR HAR			80	15		SN					M	H	FLC	TSL P	WD	C	WI	GH	BT	G	5	ECHO BAY RESORT			35	35	BM	S	M				M	H	FLC	TSL P	WD	C	WI	GH	BT	G	6	OVERTON BEACH			100			S					M		F C	TSL	WD		WI	G	BT	G	7	CALLVILLE BAY M			100	40		S					M	H	F C	TS P	WD		WI	G	B	G
	NO	LOCATION	TIDES	DEPTH	SERVICES						SUPPLIES																																																																																																																																																																																														
			APPROACH-FEET (REPORTED)	ALONGSIDE-FEET (REPORTED)	RAMP SURFACED-NATURAL	ELECTRICITY-MOORINGS-BERTHS	REPAIRS HULL-MOTOR-RADIO	MARINE RAILWAY-FEET	LIFT CAPACITY-TONS	BOAT RENTAL	CANOE-ROW-MOTOR	FOOD-LODGING-CAMPING	CHARTER-HOUSE-SAIL	PUMP OUT STATION	WINTER STORAGE-LAUNDRY	NAUTICAL CHART SALES	WATER-ICE	GROCERIES-HARDWARE	BAIT-TACKLE	DIESEL OIL-GASOLINE																																																																																																																																																																																					
	1	LAS VEGAS BOAT			80	20		S	HM				M			F C	T P	WD	C	WI	GH	BT	G																																																																																																																																																																																		
	2	LAKE MEAD MAR			80	15	B E	S	HM				M			FL	T P	WD	C	WI			DG																																																																																																																																																																																		
	3	HEMENWAY HARBOR			80			S																																																																																																																																																																																																	
	4	TEMPLE BAR HAR			80	15		SN					M	H	FLC	TSL P	WD	C	WI	GH	BT	G																																																																																																																																																																																			
	5	ECHO BAY RESORT			35	35	BM	S	M				M	H	FLC	TSL P	WD	C	WI	GH	BT	G																																																																																																																																																																																			
	6	OVERTON BEACH			100			S					M		F C	TSL	WD		WI	G	BT	G																																																																																																																																																																																			
7	CALLVILLE BAY M			100	40		S					M	H	F C	TS P	WD		WI	G	B	G																																																																																																																																																																																				
(+) DENOTES HOURS LATER (-) DENOTES HOURS EARLIER THE LOCATIONS OF THE ABOVE PUBLIC MARINE FACILITIES ARE SHOWN ON THE CHART BY LARGE PURPLE NUMBERS. THE TABULATED "APPROACH-FEET (REPORTED)" IS THE DEPTH AVAILABLE FROM THE NEAREST NATURAL OR DREDGED CHANNEL TO THE FACILITY. THE TABULATED "PUMPING STATION" IS DEFINED AS FACILITIES AVAILABLE FOR PUMPING OUT BOAT HOLDING TANKS. (H) APPROACH DEPTH FLUCTUATES WITH LAKE LEVELS.																																																																																																																																																																																																									
†																																																																																																																																																																																																									

Index of Abbreviations

Note—INT abbreviations are in bold type

A		
abt	About	D i
Accom	Accommodation vessel	L 17
AERO, Aero	Aeronautical light	P 60–61.1
Aero R Bn	Aeronautical radiobeacon	S 16
Aero RC	Aeronautical radiobeacon	S 16
AIS	Automatic Identification System	S 17.1–17.2
AI	Alternating	P 10.11
ALC	Articulated Load Column	L 12
Am	Amber	P 11.8
anc	Ancient	
ANCH, Anch	Anchorage	N 20
ANT, Ant	Antenna	E 31
approx	Approximate	
Apprs	Approaches	
Apr	April	
Apt	Apartment	E s
Arch	Archipelago	
ASL	Archipelagic Sea Lane	M 17
ATBA	Area To Be Avoided	M 29.1
Aug	August	
auth	Authorized	K 46.2
Ave	Avenue	
B		
B	Bay, bayou	
B	Black	Q 2
Bdy Mon	Boundary mark (monument)	B 24
Bk	Bank	
bk	Black	J as
bk	Broken	J 33
Bkw	Breakwater	F 4.1
bl	Black	J as
BM	Bench Mark	B 23
Bn, Bns	Beacon(s)	M 2, P 4–5, Q 80–81
BnTr, BnTrs	Beacon tower(s)	P 3, Q 110
Bo	Boulder(s)	J 9.2
Bol	Bollard	

Br	Breakers	K 17
br	Brown	J az
brg	Bearing	B 62
brk	Broken	J 33
Bu	Blue	P 11.4
C		
C	Can, cylindrical	Q 21
C	Cape	
C	Cove	
c	Coarse	J 32
Ca, ca	Calcareous	J 38
CALM	Catenary Anchor Leg Mooring	L 16
Cap	Capitol	E t
Cas	Castle	E 34.2
Cb	Cobbles	J 8
cbl	Cable	B 46
cd	Candela	B 54
Cem	Cemetery	E 19
CG	Coast Guard station	T 10
Ch	Chocolate	J ba
Ch	Church	E 10.1
Chan	Channel	
Chem	Chemical	L 40.1–40.2
CHY, Chy, Chys	Chimney(s)	E 22
Cir	Cirripedia	J ae
Ck	Chalk	J f
CL	Clearance	D 20–21, 26, 28
Cl	Clay	J 3
cm	Centimeter(s)	B 43
Cn	Cinders	J p
Co	Company	E u
Co	Coralline Algae	J 10, K 16
Co Hd	Coral Head	J i
Co rf	Coral reef	
COLREGS	International Regulations for Preventing Collisions at Sea	N a
Consol	Consol Beacon	S 13
constr	Construction	F 32

Corp	Corporation	E v
cov	Covers	L 21.2
cps	Cycles per second	B j
Cr	Creek	
CRD	Columbia River Datum	H j
crs	Coarse	J 32
c/s	Cycles per second	B j
Cswy	Causeway	F 3
Ct Ho	Courthouse	E o
Cup	Cupola	E 10.4
Cus Ho	Customs house	F 61
Cy	Clay	J 3
D		
D	Destroyed	
dec	Decayed	J an
Dec	December	
Deg	Degree(s)	B n
Destr	Destroyed	
dev	Deviation	B 67
DF	Direction Finder	
DG	Degaussing Range	N 25, Q 54
DGPS	Differential Global Positioning System	S 51
Di	Diatoms	J aa
DIA, Dia	Diaphone	R 11
Dir	Direction light	P 30–31
Discol	Discolored	K e
dist	Distant	
dk	Dark	J bd
dm	Decimeter(s)	B 42
Dn, Dns	Dolphin(s)	F 20
Dol	Dolphin(s)	F 20
DW	Deep Water Route	M 27.1, N 12.4
DZ	Danger Zone	Q 50
E		
E	East	B 10
ED	Existence Doubtful	I 1
EEZ	Exclusive Economic Zone	N 47

Index of Abbreviations

Note—INT abbreviations are in bold type

Entr	Entrance	
ESSA	Environmentally Sensitive Sea Area	N 22
Est	Estuary	
exper	Experimental	
Explos	Explosive	R 10
Exting, exting	Extinguished	P 55
F		
f	Fine	J 30
F FI	Fixed and flashing	P 10.10
F Gp FI	Fixed and Group Flashing	P d
Facty	Factory	E d
FAD	Fish Aggregating Device	
Fd	Fjord	
FISH	Fishing	N 21
FI	Flashing	P 10.4
fl	Flood	H q
Fla	Flare stack	L 11
fly	Flinty	J ao
fm, fms	Fathom(s)	B 48
fne	Fine	J 30
Fog Det Lt	Fog detector light	P 62
Fog Sig	Fog Signal	R 1
FP	Flagpole	E 27
FPSO	Floating Production, Storage and Offloading Vessel	L 17
Fr	Foraminifera	J y
Fs, FS	Flagstaff	E 27
Fsh stks	Fishing stakes	K 44.1
FT, ft	Foot, Feet	B 47, D 20
Fu	Fucus	J af
G		
G	Gravel	J 6
G	Green	P 11.3, Q 2
G	Gulf	
GAB, Gab	Gable	E i
GCLWD	Gulf Coast Low Water Datum	H k
GI	Globigerina	J z

glac	Glacial	J ap
gn	Green	J av
Govt Ho	Government House	E m
Gp FI	Group flashing	P 10.4
Gp Oc	Group occulting	P 10.2
GPS	Global Positioning System	
Grd	Ground	J a
Grs	Grass	J v
grt	Gross Register Tonnage	
GT	Gross Tonnage	
gty	Gritty	J am
gy	Gray	J bb
H		
H	Helicopter	T 1.4
h	Hard	J 39
h	Hour	B 49
HAT	Highest Astronomical Tide	H 3
Hbr Mr	Harbormaster	F 60
HHW	Higher High Water	H b
Hk	Hulk	F 34, K 20–21
Ho	House	
hor	Horizontally disposed	P 15
Hor CL	Horizontal clearance	D 21
Hosp	Hospital	E g, F 62.2
hr	Hour	B 49
hrd	Hard	J 39
ht	Height	H p
HW	High Water	H a
HWF&C	High Water Full & Change	H h
Hz	Hertz	B g
I		
IALA	International Association of Lighthouse Authorities*	Q 130
IHO	International Hydrographic Organization	
illum	Illuminated	P 63
IMO	International Maritime Organization	

In	Inlet	
in, ins	Inch(es)	B c
Inst	Institute	E n
INT	International	A 2, T 21
Intens	Intensified	P 46
IQ	Interrupted quick	P 10.6
ISLW	Indian Spring Low Water	H g
Iso	Isophase	P 10.3
ITZ	Inshore Traffic Zone	M 25.1
IUQ	Interrupted ultra quick	P 10.8
IVQ	Interrupted very quick	P 10.7
J		
Jan	January	
Jul	July	
Jun	June	
K		
K	Kelp	J u
kc	Kilocycle	B k
kHz	Kilohertz	B h
km	Kilometer(s)	B 40
kn	Knot(s)	B 52
L		
L	Lake, loch, lough	
L FI	Long-flashing	P 10.5
La	Lava	J l
Lag	Lagoon	
LANBY	Large Automatic Navigational Buoy	Pf
LASH	Lighter Aboard Ship	
LAT	Lowest Astronomical Tide	H 2
Lat	Latitude	B 1
Ldg	Landing	F 17
Ldg	Leading Lights	P 20.3
Le	Ledge	
LLW	Lower Low Water	H e
Lndg	Landing for boats	F 17
LNG	Liquified Natural Gas	

*Now known as the International Association of Marine Aids to Navigation and Lighthouse Authorities. The organization, formerly called the International Association of Lighthouse Authorities/Association Internationale de Signalisation Maritime (IALA/AISM), continues to use IALA as an abbreviation for its full name.

Index of Abbreviations

Note—INT abbreviations are in bold type

LoLo	Load-on, Load-off	
Long	Longitude	B 2
LPG	Liquified Petroleum Gas	
Lrg	Large	J a
LS S	Life saving station	T 12
lt	Light	J bc
Lt Ho	Light house	P 1
Lt, Lt(s)	Light(s)	P 1
Ltd	Limited	E r
LW	Low Water	H c
LWD	Low Water Datum	H d
LWF&C	Low Water Full and Change	H i
M		
M	Mud, muddy	J 2
M	Nautical mile(s)	B 45
m	Medium (in relation to sand)	J 31
m	Meter(s)	B 41
m	Minute(s) of time	B 50
Ma	Mattes	J ag
mag	Magnetic	B 61
Magz	Magazine	E I
Maintd	Maintained	P 65
man	Manually activated	P 56, R 2
Mar	March	
Mc	Megacycles	B I
Mds	Madrepores	J j
MHHW	Mean Higher High Water	H 13
MHLW	Mean Higher Low Water	H 14
MHW	Mean High Water	H 5
MHWN	Mean High Water Neaps	H 11
MHWS	Mean High Water Springs	H 9
Mi	Nautical mile(s)	B 45
min	Minimum	K 46.2
min	Minute(s) of time	B 50
Mk	Mark	Q 101
MI	Marl	J c
MLHW	Mean Lower High Water	H 15
MLLW	Mean Lower Low Water	H 12

MLW	Mean Low Water	H 4
MLWN	Mean Low Water Neaps	H 10
MLWS	Mean Low Water Springs	H 8
mm	Millimeter(s)	B 44
Mn	Manganese	J q
Mo	Morse Code	P 10.9, R 20
MON, Mon	Monument	E 24
MR	Marine Reserve	N 22
MRCC	Maritime Rescue and Coordination Center	
Ms	Mussels	J s
MSL	Mean Sea Level	H 6
Mt	Mountain, Mount	
Mth	Mouth	
MTL	Mean Tide Level	H 1
N		
N	North	B 9
N	Nun	Q 20
NE	Northeast	B 13
NGA	National Geospatial-Intelligence Agency	
NM	Nautical miles(s)	B 45
NMi	Nautical mile(s)	B 45
No	Number	N 12.2
NOAA	National Oceanic and Atmospheric Administration	
NOS	National Ocean Service	
Nov	November	
Np	Neap tide	H 17
NT	Net Tonnage	
NTM	Notice to Mariners	
NW	Northwest	B 15
NWS SIG STA	National Weather Service signal station	T 29
O		
Obs Spot	Observation spot	B 21
OBSC, Obscd	Obscured	P 43
Obstn	Obstruction	K 41
Oc	Occulting	P 10.2

Occas	Occasional	P 50
Oct	October	
ODAS	Ocean Data Acquisition System	Q 58
Or	Orange	P 11.7
OVHD	Overhead	D 28
Oys	Oysters	J r
P		
P	Pebbles	J 7
P	Pillar	Q 23
(P)	Preliminary (NTM)	
PA	Position approximate	B 7
Pass	Passage, Pass	
Pav	Pavilion	E p
PD	Position doubtful	B 8
Pk	Peak	
PLT STA	Pilot station	T 3
Pm	Pumice	J m
PO	Post office	F 63
Po	Polyzoa	J ad
pos, posn	Position	
Post Off	Post office	F 63
Priv, priv	Private	P 65, Q 70
Prod well	Production well	L 20
PROHIB	Prohibited	N 2.2
PSSA	Particularly Sensitive Sea Area	N 22
Pt	Pteropods	J ac
Pyl	Pylon	D 26
Q		
Q	Quick	P 10.6
QTG	Service producing DF signals	S 15
Quar	Quarantine	F e
Qz	Quartz	J g
R		
R	Coast radio station providing QTC service	S 15
R	Radio Station	S 15
R	Red	P 11.2
R, r	Rock, Rocky	J 9.1, K b

Index of Abbreviations

Note—INT abbreviations are in bold type

R Bn	Circular radiobeacon	S 10
R Lts	Air obstruction lights	P 61.2
R Mast	Radio mast	E 28
R Sta	Radio Station	S 15
R Tower	Radio tower	E 29
R TR, R Tr	Radio tower	E 29
Ra	Radar	M 31–32, S 1
Ra	Radar reference line	M 32.1
Ra (conspic)	Radar conspicuous point	S 5
Ra Ref	Radar reflector	S 4
Racon	Radar transponder beacon	S 3
Radar Sc	Radar scanner	E 30.3
Radar Tr, RADAR TR	Radar tower	E 30.2
Ramark	Radar marker beacon	S 2
RC	Circular radiobeacon	S 10
RD	Directional radiobeacon	S 11
Rd	Radiolaria	J ab
Rd	Road, roadstead	
rd	Red	J ay
RDF	Radio direction finding station	S 14
Ref	Refuge	Q 124
Rep	Reported	I 3
Rf	Reef	
RG	Radio direction finding station	S 14
Rk	Rocks	J 9.1, K b
Rky	Rocky	J 9.1
RoRo	Roll-on, Roll-off Ferry (RoRo Terminal)	F 50
rt	Rotten	J aj
Ru, (ru)	Ruin, ruined	D 8, E 25.2, F 33
RW	Rotating-pattern radiobeacon	S 12
S		
S	Sand	J 1
S	South	B 11
S	Spar, spindle	Q 24
s	Second(s) of time	B 51, P 12
SALM	Single Anchor Leg Mooring	L 12

SBM	Single Buoy Mooring	L 16
Sc	Scanner	E 30.3
Sc	Scoriae	J o
Sch	Schist	J h
Sch	School	E f
SD	Sailing Directions	
Sd	Sound	
SD	Sounding doubtful	I 2
SE	Southeast	B 14
sec	Seconds of time	B 51
Sep	September	
sf	Stiff	J 36
sft	Soft	J 35
Sg	Seagrass	J 13.3
Sh	Shells	J 11
Shl	Shoal	
Si	Silt	J 4
Sig	Signal	R 1, T 25.2
Sig Sta	Signal station	T 20
S-L Fl	Short-Long Flashing	P b
S/M	Sand over mud	J 12.1
sml	Small	J ah
SMt	Seamount	
Sn	Shingle	J d
so	Soft	J 35
Sp	Church spire	E 10.3
SP	Spherical	Q 22
Sp	spire	E 10.3
Sp	Spring tide	H 16
SpG	Sponge	J t
Spi	Spicules	J x
Spipe, S'pipe	Standpipe	E 21
spk	Speckled	J al
SPM	Single Point Mooring	L 12
SS	Signal station	T 20–36
St	Stones	J 5
St M, St Mi	Statute mile(s)	B e

STA, Sta	Station	F 41.1, S 15, T 3
stf	Stiff	J 36
Stg	Sea-tangle	J w
stk	Sticky	J 34
Str	Strait	
Str	Stream	H I
str	Streaky	J ak
sub	Submarine	K d
Subm	Submerged	K 43.1
SW	Southwest	B 16
sy	Sticky	J 34
T		
T	Short ton(s)	B m
T	Telephone	E q
T	TRUE	B 63
T	Tufa	J n
t	Ton(s), Tonnage (weight)	B 53, F 53
Tel	Telegraph	D 27
Tel off	Telegraph office	E k
Temp, temp	Temporary	P 54
ten	Tenacious	J aq
Tk	Tank	E 32
TR, Tr, Trs	Tower(s)	E 10.2, E 20
TSS	Traffic Separation Scheme	M 20.1
TT	Tree tops	C 14
TV Mast	Television mast	E 28
TV Tower	Television tower	E 29
U		
ULCC	Ultra Large Crude Carrier	
Uncov	Uncovers	K 11
unev	Uneven	J bf
Univ	University	E h
UQ	Ultra quick	P 10.8
UTC	Coordinated Universal Time	
UTM	Universal Transverse Mercator	
V		
v	Volcanic	J 37

Index of Abbreviations

Note—INT abbreviations are in bold type

var, VAR	Variation	B 60
vard	Varied	J be
vel	Velocity	H n
vert	Vertically disposed	P 15
Vert CL	Vertical clearance	D 20, 28
Vi	Violet	P 11.5
Vil	Village	D 4
VLCC	Very Large Crude Carrier	G 187
vol	Volcanic, Volcano	J 37
Vol Ash	Volcanic ash	J k
VQ	Very quick	P 10.7
VTS	Vessel Traffic Service	
W		
W	West	B 12
W	White	P 11.1
Wd	Weed	J 13.1
Well	Wellhead	L 21
WGS	World Geodetic System	S 50
Wh	White	J ar
Whf	Wharf	F 13
WHIS, Whis	Whistle	R 15
Wk, Wks	Wreck(s)	K 20
Wtr Tr, WTR TR	Water tower	E 21
Y		
Y	Yellow, Orange, Amber	P 11.6–11.8
yd, yds	Yard(s)	B d
yl	Yellow	J aw
μ		
μs, μsec	Microsecond(s)	B f

Index

A	
Abandoned railroad	D c
Accommodation vessel	L 17
Accurate position	B 32, E 2
Aerial cableway dish	D 25 E 31
Aero light	P 60
Aeronautical radiobeacon	S 16
Air obstruction light	P 61.1–61.2
Airfield	D 17
Airport	D 17
AIS	S 17.1–17.2
All-round light	P 42.1–43.2
Alternate course	M c
Alternating light	P 10.11
Amber	P 11.8
Anchor berth	N 11.1–11.2
Anchorage areas	N 10–14
buoy	Q j
for sea-planes	N 14
Anchoring prohibited	N 20
Annual change	B 70
Anomaly, magnetic	B 82.1–82.2
Antenna	E 31
Apparent shoreline	C p
Approximate depth contour	I 31
height of top of trees	C 14
position	B 7, 33, E 2
topographic contour	C 12
vertical clearance	D i
Aquaculture	K 44.1–48.2
Archipelagic Sea Lane (ASL)	M 17
Areas	N
pipeline	L 40.2, L 41.2
restricted	M 14, N 2.1
to be avoided	M 14, 29.1–29.2
wire drag	I 24
Articulated Loading Column (ALC)	L 12
Ash, volcanic	J k
Astronomical tide	H 2–3

Automatic Identification System (AIS) transmitter	S 17.1–17.2
Awash, rock	K 12
B	
Band, S & X	S 3.1–3.2
Bar code	A d
Barrage, flood	F 43
Barrel buoy	Q 25
Barrier	
floating	F 29.1
oil retention	F 29.2
security	F 29.1, Q q
Bascule bridge	D 23.4
Basin	F 27–28
Battery	E 34.3
Battery (fortification)	E 34.3
Beacon	Q 80–126
<i>articulated</i>	P 5
<i>buoyant</i>	P 5
<i>leading</i>	Q 102.2, 120
<i>lighted</i>	P 3–5
<i>marking a clearing line</i>	Q 121
<i>marking measured distance</i>	Q 122
<i>on submerged rock</i>	Q 83
<i>radar</i>	S 2–3.6
<i>radio</i>	S 10–16
<i>resilient</i>	P 5
<i>topmarks</i>	Q 9–11, 82, 102.1
<i>towers</i>	P 3, Q 110–111
Bearing	B r
Being reclaimed	F 31
Bell	R 14
buoy	Q a, R 21
on land	T a
Benchmark	B o
Berth	
anchor	N 11.1–11.2
dangerous cargo	F 19.3
designation	F 19.1, N 11.1–11.2, Q 42
visitors	F 19.2
yacht	F 11.2
Bifurcation buoy	Q h
Black	J as, Q 2
Blind, duck	K j–k
Blockhouse	E 34.2
Blue	J au, P 11.4

Board (leading beacon)	Q 102.2
Boarding place, pilot	T 1.1–1.4
Boat harbor, marina	F 11.1
Boom	F 29.1
Boulders international	J 9.2 N 40–41
Boundary IALA region	Q 130
Breakers	C d, K 17
Breakwater	F 4.1–4.3
Bridge	D 20.1–24
<i>bascule</i>	D 23.4
<i>draw</i>	D 23.6
<i>fixed</i>	D 20.1
<i>lifting</i>	D 23.3
<i>light (traffic signal)</i>	T 25.2
<i>passage signal station</i>	T 25.1
<i>pontoon</i>	D 23.5
<i>swing</i>	D 23.2
<i>transporter</i>	D 24
<i>under construction</i>	D d
Broken	J 33
Brown	J az
Bubbler curtain, bubbler	F 29.2
Buildings	D 2, 5–6, 8
Buoyage system, IALA	Q 130–130.7
Buoyant beacon	P 5
Buoy	Q 20–71
<i>cardinal</i>	Q 130.3
<i>isolated danger</i>	Q 130.4
<i>lateral</i>	Q 130.1
<i>mooring</i>	Q 40–45
<i>new danger</i>	Q 130.7
<i>safe water</i>	Q 130.5
<i>scientific mooring</i>	Q r
<i>special</i>	Q 130.6
Buried pipeline	L 42.1
Bushes	C o
C	
Cable	
ferry	M 51
landing beacon	Q 123
overhead	D 26–27, H 20
submarine	L 30.1–32
Cableway (aerial)	D 25
Cairn	Q 100

Index

CALM (Catenary Anchor Leg Mooring)	L 16	Clay	J 3	Continuous	
Caisson	F 42	Clearance		<i>quick</i>	P 10.6
Calcareous	J 38	<i>horizontal</i>	D 21	<i>ultra quick</i>	P 10.8
Calling-in point	M 40.1	<i>safe vertical</i>	D 26, i	<i>very quick</i>	P 10.7
Calvary cross	E 24	<i>vertical</i>	D 22, 23.1, 23.4, 23.6–28	Contour	
Camping site	E 37.1–37.2	Cleared platform	L 22	<i>depth</i>	I 30–31
Can buoy	Q 21	Clearing line	M 2	<i>drying</i>	I 15, 30
Canal	F 40	Clearing line beacon	Q 121	<i>topographic</i>	C 10, 12, H 20
<i>distance mark</i>	B 25.1–25.2	Cliffs	C 3	Control point	B 20–24
Candela	B 54	Coal head	J i	Conversion scales	A a
Cardinal marks	Q 130.3	Coarse	J 32	Conveyor	F g
Careening grid	F 24	Coast		Copyright note	A 5
Cargo transshipment area	N 64	<i>flat</i>	C 5	Coral	J 10, 22, K 16, h, m
Castle	E 34.2	<i>radar station</i>	S 1	Coral reef	
Casuarina	C 31.6	<i>radio station providing QTG service</i>	S 15	<i>always covers</i>	K 16
Causeway	F 3	<i>steep</i>	C 3	<i>covers and uncovers</i>	J 22, K m
Cautionary notes	A 16	Coast Guard station	T 10–11	<i>detached</i>	K h
Cemetery	E 19	Coastline	C 1–8	Coralline algae	J 10
Centimeter	B 43	<i>surveyed</i>	C 1	Corner coordinates	A 9
Chalk	J f	<i>unsurveyed</i>	C 2	Covers	J 21–22, K 11, 16, 21
Channel	I 20–22	Cobbles	J 8	Crane	F 53.1–53.3
Chart		Colored mark	Q 101	Crib	K i–j, L 43, b
<i>datum</i>	A 3, C a, H 1, 20	Colored topmark	Q 102.1	Crossing gates	M 22
<i>dimension</i>	A 8	Colors		Crossing, traffic separation	M 23
<i>number</i>	A 1–2	<i>beacons</i>	Q 2–5	Cubic meter	B b
<i>reference to another</i>	A 18–19	<i>buoys</i>	Q 2–5	Cultivated	
<i>scale</i>	A 13	<i>lights</i>	P 11.1–11.8	<i>fields</i>	C i
<i>title</i>	A 10	<i>topmarks</i>	Q 2–5	<i>shellfish</i>	K 47
Chemical dumping ground	N 24	COLREGS demarcation line	N a	Cultural features	D
Chemical pipeline	L 40.1–40.2	Columbia River Datum	H j	Cupola	E 10.4
Chimney	E 22	Column	E 24	Current	H 42–43, m, t
Chocolate	J ba	Compass rose	A c, B 70	<i>diagram</i>	H t
Church	E 10.1	Composite		<i>in restricted waters</i>	H 42
<i>dome</i>	E 10.4	<i>group-flashing</i>	P 10.4	Customs	
<i>spire</i>	E 10.3	<i>group-occulting</i>	P 10.2	<i>house</i>	F 61
<i>tower</i>	E 10.2	Conical buoy	Q 20	<i>limit</i>	N 48
Cinders	J p	Conifer	C 31.3, j	<i>office</i>	F 61
Circular (non-directional) aeromarine radiobeacon	S 10	Consol beacon	S 13	Cutting	D 14
Circular (non-directional) marine radiobeacon	S 10	Conspicuous landmark	E 2	Cycles per second	B j
Cirripedia	J ae	Conspicuous, radar	S 5	Cylindrical buoy	Q 21
		Container crane	F 53.2	Cypress buoy	C r
		Contiguous zone	N 44		
		Continental shelf	N 46		

Index

D	
Dam	F 44
Danger	
<i>firing area</i>	N 30, Q 50, 125
<i>isolated mark</i>	Q 130.4
<i>line</i>	K 1
<i>signal station</i>	T 35
<i>zone</i>	Q 50
Dangerous	
cargo berth	F 19.3
rock	K 10–13, 14.2
wreck	K 28
Dark	J bd
Data collection buoy	Q 58
Datum	
<i>chart</i>	H 1, 20
<i>sounding reduction</i>	H 1
Daymark (dayboard)	Q 10, 80–81, 110, I
Daytime light	P 51
Deadhead	K 43.2
Decayed	J an
Deciduous	
<i>woodland</i>	C i
Decimeter	B 42
Deep water	
<i>anchorage area</i>	N 12.4
<i>route</i>	M 27.1–27.3
Degaussing range	N 25
<i>buoy</i>	Q 54
Degree	B 4
Depth	
<i>charted</i>	H 20
<i>contours</i>	I 30
<i>minimum</i>	K 46.2, M 27.2
<i>observed</i>	H 20
<i>out of position</i>	I 11
<i>safe clearance</i>	K 3, 30, f
<i>swept</i>	I 24, a, b, K 2, 27, 42, f
<i>units used for</i>	A b
<i>unknown</i>	K 3, 13, 23, 28, 30, 40, a, L 21.1
Depths	I
Derrick, oil	L 10

Designation of	
<i>beacon</i>	Q 10
<i>berth</i>	F 19.1
<i>buoy</i>	Q 11
<i>platform</i>	L 2
<i>reporting point</i>	M 40.1
<i>tidal stream, position of tabulated data</i>	H 46
<i>transit shed</i>	F 51
Detector light	P 62
Development area	L 4
Deviation	
<i>dolphin</i>	F 21
DGPS correction transmitter	S 51
Diaphone	R 11
Diatoms	J aa
Diffuser	L 43
Dike	F 1
Direction	
<i>of buoyage</i>	Q 130.2
<i>finding, radio station</i>	S 14
<i>of flow</i>	F 44
<i>light</i>	P 30.1–31
<i>of traffic</i>	M 10, 11, 26.1–26.2, 40.1
Directional radiobeacon	S 11
Directions, compass	B
Discolored water	K e
Dish aerial	E 31
Disposition of lights	P 15
Distance	B
<i>along waterway</i>	B 25.1–25.2
<i>measured, beacons marking</i>	Q 122
Disused	
<i>pipeline/pipe</i>	L 44
<i>platform</i>	L 14
<i>submarine cable</i>	L 32
Diurnal tide	H 30
Dock	
<i>dry, graving</i>	F 25
<i>floating</i>	F 26
<i>wet</i>	F 27
Dolphin	F 20–21
Dome	E 30.4
Doubtful	
<i>depth</i>	I 2
<i>existence</i>	I 1
<i>position</i>	B 8

Draft	M 6, N 12.4
<i>area</i>	I 20–22
<i>channel</i>	I 20–22
Dredging (extraction) area	N 63
Drying	
<i>contour</i>	I 30
<i>height</i>	H 20, I 15
Duck blind	K j–k
Dumping ground	N c, d, g
<i>chemical waste</i>	N 24
<i>explosives</i>	N 23.1–23.2
Dunes	C 8
E	
East	B 10
<i>cardinal mark</i>	Q 130.3
Ebb tide stream	H 41
Eddies	H 45
Edition note	A 6
Eelgrass	C t
Elevation of light	H 20, P 13
Ellipsoid	A 3
Embankment	D 15
Entry prohibited area	N 2.2, 31
Environmentally Sensitive Sea Area (ESSA)	N 22
Established (mandatory) direction of traffic flow	M 10
Eucalypt	C 31.8
Evergreen	C 31.2
Example of	
<i>conspicuous landmarks</i>	E 2
<i>fog signal descriptions</i>	R 20–22
<i>full light description</i>	P 16
<i>landmarks</i>	E 1
<i>routing measures</i>	M 18–29.2
Exclusive Economic Zone (EEZ)	N 47
Exercise area, submarine	N 33
Existence doubtful	I 1
Explanatory notes	A 11, 16
Explosive fog signal	R 10
Explosives	
<i>anchorage area</i>	N 12.7
<i>dumping ground</i>	N 23.1–23.2
Extinguished light	P 55

Index

Extraction area	N 63	Floating		Graving dock	F 25
F		<i>barrier</i>	F 29.1	Gray	J bb
Factory	E d	<i>dock</i>	F 26	Green	J av, P 11.3, Q 2
Faint sector	P 45.1–45.2	<i>oil barrier</i>	F 29.1	Gridiron	F 24
Fairway	M 18	<i>wind farm</i>	L 5.2	Gritty	J am
Farm		<i>wind turbine</i>	L 5.1	Groin	F 6
<i>marine</i>	K 48.1–48.2	Flood	H q	Ground	J a
<i>wave</i>	L 6	<i>barrage</i>	F 43	<i>tackle</i>	Q 42
<i>wind</i>	L 5.2	<i>tide (stream)</i>	H 40	Group	
Fast ice, limit	N 60.1	Floodlit, floodlight	P 63	<i>fixed and flashing</i>	P d
Fathom(s)	B 48	Fog		<i>flashing</i>	P 10.4
Feet	B 47	<i>detector light</i>	P 62	<i>occluding</i>	P 10.2
Fence	D g	<i>light</i>	P 52	<i>quick</i>	P 10.6
Ferry	M 50–51	<i>signals</i>	R	<i>short flashing</i>	P c
<i>terminal, RoRo</i>	F 50	Foot	B 47	<i>very quick</i>	P 10.7
Filao	C 31.7	Footbridge	D 20.2	Gulf Coast Low Water Datum	H k
Fine	J 30	Foraminifera	J y	Gulf Stream limits	H u
Fireboat station	T c	Foreshore	C c	Gun	R 10
Firing		Form lines	C 13	H	
<i>danger area</i>	N 30	Fort	E 34.2	Hachures	C f
<i>danger area buoy</i>	Q 50	Fortified structure	E 34.1	Harbor	
<i>practice signal station</i>	T 36	Foul		<i>installations</i>	F 10–34
Fish		<i>area</i>	K o	<i>limit</i>	N 49
<i>haven</i>	K 46.1–46.2	<i>ground</i>	K 31.1–31.2	<i>master's office</i>	F 60
<i>marine farm</i>	K 48.1–48.2	Front light	P 23	Harbors	F
<i>trap</i>	K 44.2–45, Q i	Fucus	J af	Hard	J 39
<i>weir</i>	K 44.2	G		Health office	F 62.1
Fishery zone limit	N 45	Gable	E i	Height	H p
Fishing		Gas		<i>datum</i>	H 20
<i>harbor</i>	F 10	<i>pipe line</i>	L 40.1	<i>drying</i>	H 20, I 15
<i>limit (fish trap area)</i>	N b	<i>pipeline area</i>	L 40.2	<i>light (elevation of)</i>	H 20, P 13
<i>prohibited</i>	N 21.1	Gasfield name	L 1	<i>rocks</i>	K 10–11
<i>stakes</i>	K 44.1	Gate	F 42	<i>spot</i>	C 10–11, 13, H 20
Fixed		Geographical positions	B 1–16	<i>of structure</i>	E 4–5
<i>bridge</i>	D 20.1	Glacial	J ap	<i>tide</i>	H 20, P 13
<i>flashing, and</i>	P 10.10, d	Glacier	C 25	<i>of top of trees</i>	C 14
<i>light</i>	P 10.1	Globigerina	J z	<i>of wellhead</i>	L 23
<i>point</i>	B 22	Glossary	A e	Helipoint, Helipad	D 18
Flagstaff, Flagpole	E 27	Gong	R 16, Q b	Hertz	B g
Flare stack	E 23, L 11	Grass	C s, J v	High water	H 20, a
Flashing light	P 10.4	Grassfields	C m	High Water Full and Change	H h
Flat coast	C 5	<i>area with</i>	J 20	Higher High Water	H 20, b
Flinty	J ao	Gravel	C c, J 6, 20	Highest Astronomical Tide (HAT)	H 3
Floot	K q, Q s			Highway	D 10
				<i>markers</i>	D a

Index

Hillocks	C 4	Joss house	E 13	<i>direction</i>	P 30.1–31
Horizontal		K		<i>disposition</i>	P 15
<i>light</i>	P 15	Kelp	J 13.1–13.2, u	<i>elevation</i>	P 13
<i>clearance</i>	D 21	Kilocycle	B k	<i>exhibited only when specially needed</i>	P 50
Horizontally disposed	P 15	Kilohertz	B h	<i>faint sector, with</i>	P 45.1–45.2
Horn	R 13	Kilometer	B 40	<i>float</i>	Q 30.1–31
Hospital	E g, F 62.2	Knot	B 52, H o	<i>in line</i>	P 21.1–21.2
Hour	B 49	L		<i>intensified sector, with</i>	P 46.1–46.2
Hulk	F 34, K 20–21, 23	Lake	C 21, 23	<i>landmarks, on</i>	P 7
I		<i>intermittent</i>	C 21	<i>leading</i>	P 20.1–23
IALA Maritime Buoyage System	Q 130	LANBY	P f	<i>marking fairway</i>	P 20.1–23
Ice		Landing		<i>Moiré effect</i>	P 31
<i>boom</i>	F 29.1	<i>beacon (cable)</i>	Q 123	<i>period</i>	P 12
<i>fast (ice front)</i>	N 60.1	<i>boats, for</i>	F 17	<i>range</i>	P 14
<i>sea ice (pack ice) seasonal</i>	N 60.2	<i>seaplanes, for</i>	N 13	<i>sector</i>	P 40.1–46.2
<i>signal station</i>	T 30	<i>stairs</i>	F 18	<i>special</i>	P 60–66
Illuminated	P 63	Landmarks	E	<i>structures</i>	P 1–7
Imprint	A 4	Lane, submarine transit	N 33	<i>synchronized</i>	P 66
Inadequately surveyed area	I 25	Large	J ai	<i>times of exhibition</i>	P 50–55
Inch	B c	Large Automatic Navigational Buoy (LANBY)	P f	<i>vessel</i>	P e, Q 32
Incineration area	N 65	Lateral marks (IALA System)	Q 130.1	Light characters	P 10.1–10.11
Indian Spring Low Water	H g	Latitude	B 1	Lighted	
Inshore traffic zone	M 25.1–25.2	Lattice beacon	Q 111	<i>beacon</i>	P 4, Q o
Installations, offshore	L	Lava	C 26, J 9, I	<i>beacon tower</i>	P 3
Intake pipe	L 41.1–41.2, b	Layout of chart	A	<i>marks</i>	Q 7–8
Intense	P 46.1–46.2	Leading		<i>mooring buoy</i>	Q 41
Intensified sector	P 46.1–46.2	<i>beacons</i>	Q 120	<i>offshore platform</i>	P 2.1–2.2
Intermittent river	C 21	<i>lights</i>	P 20.1–23	Lighthouse	P 1
International		<i>line</i>	M 1	Lights	P
<i>boundary</i>	N 40–41	Least depth	K 26–27, 30	Lights exhibited only when specially needed	P 50
<i>chart number</i>	A 2	<i>in narrow channel</i>	I 12	Lights in line	P 21.1–21.2
<i>nautical mile, sea mile</i>	B 45	Leisure facilities	U	Lights Marking Fairways	P 20.1–23
Interrupted light		Levee	F 1	Lights with limited times of exhibition	P 50–55
<i>quick</i>	P 10.6	Lifeboat	T 12–13	Limit of	
<i>ultra quick</i>	P 10.8	<i>mooring</i>	T 13	<i>area feature in general</i>	C q
<i>very quick</i>	P 10.7	<i>station</i>	T 12	<i>area into which entry is prohibited</i>	N 2.2, 31
Intertidal area	J 20–22	Lifting bridge	D 23.3	<i>contiguous zone</i>	N 44
Isogonic lines (Isogonals)	B 71	Light	J bc	<i>continental shelf</i>	N 46
Isolated danger mark	Q 130.4	<i>arc of visibility, with restricted</i>	P 44.1–44.2	<i>danger line</i>	K 1
Isophase light	P 10.3	<i>character</i>	P 10.1–11.8	<i>development area</i>	L 4
J		<i>chart limits, off</i>	P 8	<i>dredged area</i>	I 20
Jetty	F 14, a–c	<i>color</i>	P 11.1–11.8	<i>Exclusive Economic Zone (EEZ)</i>	N 47
		<i>description</i>	P 16	<i>fast ice</i>	N 60.1

Index

<i>safety zone</i>	L 3
<i>sea ice (pack ice) seasonal</i>	N 60.2
<i>unsurveyed area</i>	I 25
Linear scale	A 14–15
Local magnetic anomaly	B 82.1–82.2
Lock	F 41.1–41.2
<i>signal station</i>	T 24
Log pond	F 29.1
Logo	A 12
Long-flashing light	P 10.5
Longitude	B 2
Lookout	
<i>pilot station</i>	T 2 T e
Low water	H 20, c
<i>line</i>	I 30
Lower light	P 23
Lower low datum	H d
Lower low water	H e
Lower water full & change	H i
Lowest Astronomical Tide (LAT)	H 2
M	
Madrepores	J j
Magnetic	B q
<i>anomaly</i>	B 82.1–82.2
<i>compass variation</i>	B 68.1–71 B 68.1–71, p
Main light visible all-round	P 42.1–42.2
Major	
<i>light</i>	P 1
<i>light off chart limits</i>	P 8
Manganese	J q
Mangrove	C 32
Manually activated	P 56, R 2
Marabout	E 13
Marginal notes	A
Marina	F 11.1
<i>facilities</i>	U a
Marine	
<i>farm reserve</i>	K 48.1–48.2 N 22
Maritime limit	N 1.1–1.2

Marks	
<i>cardinal</i>	Q 130.3
<i>colored</i>	Q 101
<i>isolated danger</i>	Q 130.4
<i>lateral</i>	Q 130.1
<i>lighted</i>	Q 7–8
<i>minor</i>	Q 90–102.2
<i>new danger</i>	Q 130.7
<i>safe water</i>	Q 130.5
<i>special</i>	Q 130.6
<i>wreck (new danger)</i>	Q 130.7
Marl	J c
Marsh	C 33
Mast	
<i>radar</i>	E 30.1
<i>radio, television</i>	E 28
<i>wreck</i>	K 25
Mattes	J ag
Maximum	
<i>authorized draft</i>	M 6
<i>speed</i>	N 27
Mean	
<i>High Water (MHW)</i>	H 5, 20, 30
<i>High Water Neaps (MHWN)</i>	H 11
<i>High Water Springs (MHSWS)</i>	H 9
<i>Higher High Water (MHHW)</i>	H 13, 30
<i>Higher Low Water (MHLW)</i>	H 14
<i>Low Water (MLW)</i>	H 4, 20, 30
<i>Low Water Neaps (MLWN)</i>	H 10
<i>Low Water Springs (MLWS)</i>	H 8
<i>Lower High Water (MLHW)</i>	H 15
<i>Lower Low Water (MLLW)</i>	H 12, 20, 30
<i>Sea Level (MSL)</i>	H 6, 20
<i>tide level</i>	H f
Measured Distance	Q 122
Medium	J 31
Megacycle	B l
Megahertz	B i
Meter	B 41
Microsecond	B f
Mid-channel buoy	Q e
Mile	
<i>nautical (sea mile)</i>	A 15, B 45
<i>statute</i>	B 25.1–25.2, e
<i>three nautical mile line</i>	N h
Military area	N 30–34
Millimeter	B 44
Minaret	E 17
Mine (explosive)	N 23.1

Mine (ore extraction)	E 36
Minefield	N 34
Mine-laying practice area	N 32
Minor	
<i>impermanent marks</i>	Q 90–92
<i>light</i>	P 1, note after P 5
<i>light floats</i>	Q 30.1–31
<i>marks</i>	Q 100–102.2
<i>pile</i>	F 22
<i>post</i>	F 22
Minute	
<i>of arc</i>	B 5
<i>of time</i>	B 50
Mixed bottom	J 12.1–12.2
Moiré effect light	P 31
Mole	F 12
Monument	E 24
Moored storage tanker	L 17
Mooring	
<i>berth number</i>	Q 42
<i>canal</i>	F f
<i>ground tackle</i>	L 18, Q 42
<i>life boat</i>	T 13
<i>numerous</i>	Q 44
<i>scientific mooring buoy</i>	Q r
<i>Single Buoy (SBM)</i>	L 16
<i>Single Point (SPM)</i>	L 12
<i>trot</i>	Q 42
<i>visitors'</i>	Q 45
<i>buoy</i>	Q 40–45
<i>lighted</i>	Q 41
<i>tanker</i>	L 16
<i>telegraphic</i>	Q 43
<i>telephonic</i>	Q 43
Morse Code	
<i>fog signal</i>	R a
<i>light</i>	P 10.9
Mosque	E 17
Motorway	D 10
Mud	C c, J 2
Muslim shrine	E a
Mussels	J s
N	
National	
<i>limits</i>	N 40–49
<i>park</i>	N 22
Natural	
<i>features</i>	C
<i>watercourse</i>	I 16

Index

Nature reserve of the seabed	N 22 J
Nautical mile	B 45
Nautophone	R 13
Neap tide	H 10–11, 17, 30–31
Nets, tunny	K 44.2–45
New edition date	A 6
danger mark	Q 130.7
Nipa palm	C 31.5, 32
No anchoring area	N 20
No bottom found	I 13
No discharge zone	N i
Non-dangerous wreck	K 15, 29
Non-directional radiobeacon	S 10
Non-tidal basin	F 27
North cardinal mark	B 9 Q 130.3
Northeast	B 13
Northwest	B 15
Notes	A 11, 16
Notice board	Q 126, T d
Notice to mariners	A 7
Nun buoy	Q 20
O	
Obelisk	E 24
Obscured sector	P 43.1–43.2
Observation spot	B 21
Obstruction light, air	K 40–48.2 P 61.1–61.2
Occasional light	P 50
Occulting light	P 10.2
Ocean current	H 43
ODAS buoy	L 25, Q 58
Office customs	F 61
harbormaster's health	F 60 F 62.1
pilot	T 2–3
quarantine	F e

Offshore Installations	L
platform, lighted position, tidal levels	P 2.1–2.2 H 47
Ogival buoy	Q 20
Oil barrier	F 29.1–29.2
derrick	L 10
installation buoy, Catenary Anchor Leg Mooring (CALM)	L 16
pipeline	L 40.1
pipeline area	L 40.2
Oilfield with name	L 1
One-way track	M 5.1–5.2, 27.3
Ooze	J b
Opening bridge	D 23.1
Orange	J ax, P 11.7
Ordnance, unexploded	K p
Outfall pipe	L 41.1–41.2
Overfalls	H 44
Overhead cable	D 27
pipe	D 28
transporter	D 25
Oysters	J r
P	
Pack ice, limit	N 60.2
Paddy field	C n
Pagoda	E 13
Painted board	Q 102.2
Palm	C 31.4
Park ranger station	T g
Particularly Sensitive Sea Area (PSSA)	N 22
Patent slip	F 23
Path	D 12
Pebbles	J 7
Perch	Q 91
Period of light	P 12
Pictorial sketches	E 3.1–3.2
Pier promenade	F 14 F 15
ruined	F 33.2

Pile submerged	F 22 K 43.1–43.2
Pillar buoy monument	Q 23 E 24
Pilot boarding place	T 1–4 T 1.1–1.3
helicopter transfer	T 1.4
look out office	T 2 T 2–3
Pilotage	T 1–4
Pipe intake	L 41.1–41.2, b
outfall	L 41.1–41.2
overhead pneumatic (bubbler)	D 28 F 29.2
Pipeline buried	L 42.1
land, on	D 29
overhead submarine tunnel	D 28 L 40.1–44 L 42.2
Platform cleared	L 2, 10, 13–14, 22, P 2
submerged	L 22 K i
Point base point for territorial sea baseline	N 42
fixed	B 22
Single Point Mooring (SPM)	L 12
symbols, position	B 32–33
triangulation	B 20
Pole	Q 90
Police station, marine	T b
Polyzoa	J ad
Pontoon bridge	F 16 D 23.5
Port pilotage service, with signal station	T 4 T 21–23
Ports	F
Position accurate	B 2, E 2
approximate	B 7, E 2
of buoy or beacon	Q 1
doubtful	B 8
of fog signal	R 1
of pilot cruising vessel	T 1.1–1.3
tidal levels	H 47
tidal stream data	H 46

Index

Positions	B		
<i>symbolized</i>	B 30–33		
Post	F 22, K 43.1		
<i>covers and uncovers</i>	K r		
<i>office</i>	F 63		
<i>submerged</i>	K 43.1		
Power			
<i>overhead cable</i>	D 26, H 20		
<i>submarine cable</i>	L 31.1–31.2		
<i>transmission line</i>	D h		
Practice area (military)	N 30–34		
Precautionary area	M 16, M 24		
Preferred channel buoy	Q 130.1		
Private			
<i>buoy</i>	Q 70		
<i>light</i>	P 50, 65		
Production			
<i>platform</i>	L 10		
<i>well</i>	L 20		
Prohibited			
<i>anchoring</i>	N 20		
<i>area</i>	N 2.2, 31		
<i>diving</i>	N 21.2		
<i>fishing</i>	N 21.1		
Promenade pier	F 15		
Protective structures	F 1–6.3		
Pteropods	J ac		
Public Buildings	F 60–63		
Publication note	A 4		
Pumice	J m		
Pump-out facilities	F d		
Pylon	D 26, E 29		
Q			
QTG service	S 15		
Qualifying Terms	J 30–39		
Quarantine			
<i>anchorage area</i>	N 12.8		
<i>building, health office</i>	F 62.1		
<i>office</i>	F e		
Quarry	E 35.1–35.2		
Quartz	J g		
Quay	F 13		
Quick light	P 10.6		
R			
Races	H 44		
Racon	S 3.1–3.6		
Radar			
<i>beacon</i>	S 2–3.6		
<i>conspicuous feature</i>	S 5		
<i>dome (radome)</i>	E 30.4		
<i>mast</i>	E 30.1		
<i>range</i>	M 31		
<i>reference line</i>	M 32.1–32.2		
<i>reflector</i>	Q 10–11, S 4		
<i>scanner</i>	E 30.3		
<i>station</i>	S 1		
<i>surveillance system</i>	M 30–32.2		
<i>tower</i>	E 30.2		
<i>transponder beacon, racon</i>	S 3.1–3.6		
<i>transponder beacons on floating marks</i>	S 3.6		
<i>tower</i>	E 29		
Radio	S 10–18.7		
<i>direction-finding station</i>	S 14		
<i>mast</i>	E 28		
<i>reporting line</i>	M 40.2		
<i>reporting point, calling-in or way point station, QTG service</i>	M 40.1		
<i>station, QTG service</i>	S 15		
Radiobeacon	S 10–16		
Radiolaria	J ab		
Radome	E 30.4		
Railway	D 13, b		
<i>station</i>	D 13		
Ramark	S 2		
Ramp	F 23		
Range	P 14		
Rapids	C 22		
Rate	H n		
Rear light	P 22		
Reclamation area	F 31		
Recommended			
<i>deep water track</i>	M 27.3, a–b		
<i>direction of traffic flow</i>	M 11, 26.1–26.2, 28.1		
<i>route</i>	M 28.1		
<i>track</i>	M 3–4, 6		
Red	J ay, P 11.2, Q 3		
Reed beds	C 33		
Reef	J 22, K 16, g–h, m		
Reference to			
<i>adjoining chart</i>	A 19		
<i>charted units</i>	A b		
<i>larger-scale chart</i>	A 18		
Reflector, radar	Q 10–11, S 4		
Refuge			
<i>beacon</i>	Q 124		
<i>for shipwrecked mariners</i>	T 14		
Regions, IALA	Q 130.1		
Relief	C 10–14		
Reported			
<i>anchorage</i>	N 10		
<i>danger</i>	I 4		
<i>depth</i>	I 3.1–4		
Reporting, radio	M 40.1–40.2		
Rescue station	T 11–12		
Reservation line	N f		
Reserve fog signal	R 22		
Reserved anchorage area	N 12.9		
Resilient beacon	P 5		
Restricted			
<i>area</i>	M 14, N 2.1, 20–27		
<i>light sector</i>	P 44.1–44.2		
Retroreflecting material	Q 6		
Rice paddy	C n		
Riprap	P a		
River	C 20		
<i>intermittent</i>	C 21		
Road	D 10–11		
Rock	J 9.1, K 10–15, a–b		
Rocket station	T 12		
Rocky	J 9.1		
<i>area which covers and uncovers</i>	J 21		
Roll-on, Roll-off ferry terminal (RoRo)	F 50		
Rotating-pattern radiobeacon	S 12		
Rotten	J aj		
Roundabout	M 21		
Route	M 27.1–28.2		
Routing Measures	M 18–29.2		
Rubble	C e		
Ruin	D 8, F 33.1		

Index

Ruined <i>landmark</i> <i>pier</i>	D 8 F 33.2
S	
Safe <i>clearance depth</i> <i>vertical clearance</i> <i>water mark</i>	K 3, 30, f D 26, i Q 130.5
Safety <i>fairway</i> <i>zone</i>	M 18 L 3
Sailing club	F 11.3
Salt pans	C 24
Sand	C c, J 1
Sandhills	C 8
Sandwaves	J 14
Sandy shore	C 6
Satellite Navigation System	S 50–51
Scale	A 13–15
Scanner, radar	E 30.3
Schist	J h
School	E f
Scoriae	J o
Scrubbing grid	F 24
Sea mile (nautical mile)	A 15, B 45
Seabed, types of	J 1–15, a–bf
Seagrass	J 13.3
Seal <i>chart producer</i> <i>sanctuary</i>	A 12 N 22
Seaplane <i>anchorage</i> <i>landing area, operating area</i>	N 14 N 13
Seasonal <i>buoy</i> <i>sea ice limit</i>	Q 71 N 60.2
Sea-tangle	J w
Seawall	F 2.1–2.2
Seaward limit of <i>contiguous zone</i> <i>territorial sea</i>	N 44 N 43
Second <i>of arc</i> <i>of time</i>	B 6 B 51

Sector lights	P 40.1–46.2
See adjoining chart	A 19
Semaphore	T f
Semi-diurnal tide	H 30
Separation <i>line</i> <i>scheme</i> <i>zone</i>	M 12 M 10–13, 20.1–29.2 M 13
Services	T
Settlements	D 1–8
Sewer	L 41.1–41.2
Shading	C g
Shapes of buoys	Q 20–26
Shark nets	F 29.1
Shed, transit	F 51
Shellfish bed	K 47
Shells	J 11
Shingle	C c, J d
Shingly shore	C 7
Shoal sounding on rock	K b
Shore, shoreline	C 1–8
Short-long flashing	P b
Shrine	E 13
Signal <i>fog</i> <i>stations</i>	R T 20–36
Silo	E 33
Silt	J 4
Single <i>Anchor Leg Mooring (SALM)</i> <i>Buoy Mooring (SBM)</i> <i>Point Mooring (SPM)</i>	L 12 L 16 L 12
Sinker	K n
Siren	R 12
Sketches	E 3.1–3.2
Slack water	H 31
Slipway	F 23
Small	J ah
Small craft <i>leisure facilities</i> <i>mooring</i>	U Q 44
Snag	K 43.2

Soft	J 35
Sounding <i>datum</i> <i>doubtful depth</i> <i>out of position</i> <i>unreliable</i>	I 10–16 C a, b, K h I 2 I 11 I 14
Source diagram	A 17
South <i>cardinal mark</i>	B 11 Q 130.3
Southeast	B 14
Southwest	B 16
Spar buoy	Q 24
Special <i>lights</i> <i>marks</i> <i>purpose beacon</i> <i>purpose buoy</i>	P 60–66 Q 130.6 Q 120–126 Q 50–71
Speckled	J al
Speed limit	N 27
Spherical buoy	Q 22
Spicules	J x
Spindle buoy	Q 24
Spire	E 10.3
Spoil ground	N 62.1–62.2
Sponge	J t
Spot height	C 10–11, 13, H 20
Spring <i>tide</i> <i>seabed</i>	H 16, 30–31 J 15
Square <i>meter</i> <i>shaped beacon</i>	B a Q I
Stake	K 43.2, Q 90
Station <i>Coast Guard</i> <i>coast radar</i> <i>DGPS, providing corrections</i> <i>QTG, providing radio service</i> <i>radar surveillance</i> <i>radio direction finding</i> <i>railway</i> <i>rescue</i> <i>signal</i> <i>tide</i>	T 10–11 M 30, S 1 S 51 S 15 M 30 S 14 D 13 T 11–12 T 20–36 H 30
Statute	E 24
Statute mile	B e

Index

Steep coast	C 3	Surveyed <i>coastline</i> <i>inadequately</i>	C 1 I 25	<i>scale</i>	T 32.1
Steps	F 18	Suspended well	L 21.1–21.2	<i>signal station</i>	T 33
Sticky	J 34	Swamp	C 33	<i>table</i>	A g, H 30–31
Stiff	J 36	Swept <i>area</i> <i>channel</i> <i>wire drag, by</i>	I 24, b I a K 2, 27, 42, f	Timber yard	F 52
Stock number	A d	Swing bridge	D 23.2	Time <i>signal station</i> <i>units of</i>	T 31 B 49–51
Stones <i>area with</i>	C 7, J 5 J 20	Swinging circle	N 11.2	Tomb	E b
Stony shore	C 7	Symbolized positions	B 30–33	Ton, tonnage, tonne (weight)	B 53, m
Storage tanker	L 17	Synchronized light	P 66	Topmark	Q 9–11, 82, 102.1
Storm signal station	T 28	T		Tower <i>beacon</i> <i>church</i> <i>radar</i> <i>radio</i> <i>television</i> <i>water</i>	E 20 P 3, Q 110–111 E 10.2 E 30.2 E 29 E 29 E 21
Straight territorial sea baseline	N 42	Tanker anchorage area CALM storage, moored	N 12.5 L 16 L 17	Track	D 12, M 1–6, 27.3
Strand	C c	Tank	E 32	Traffic <i>separation scheme (TSS)</i> <i>basic symbols</i> <i>example</i> <i>signal station</i> <i>surveillance station</i>	M 10–15, 20–26.2 M 10–15 M 18–29.2 T 21–22, 25.1 M 30
Streaky	J ak	Telegraphic mooring buoy	Q 43	Training wall	F 5
Stream <i>Gulf</i> <i>tidal signal station</i> <i>tidal table</i> <i>tide</i>	C 20, H I, I c H u T 34 H 31, 46 H 40–41	Telephone <i>line</i>	E q D 27	Transhipment <i>area</i> <i>facilities</i>	N 64 F 50–53.2
Street	D 7	Telephonic mooring buoy	Q 43	Transit <i>lane (submarine)</i> <i>line</i> <i>shed</i>	N 33 M 2 F 51
Strip light	P 64	Television <i>mast</i> <i>station</i> <i>tower</i>	E 28 E 27 E 29	Transmission line	D 26–27, h
Stumps of piles/posts	K 43.1–43.2	Temple	E 13	Transmitter, AIS	S 17.1–17.2
Submarine <i>cable</i> <i>cable area</i> <i>exercise area</i> <i>pipeline</i> <i>power cable</i> <i>power cable area</i> <i>transit lane</i> <i>volcano</i>	L 30.1–32 L 30.2 N 33 L 40–44 L 31.1 L 31.2 N 33 K d	Temporary <i>buoy (seasonal)</i> <i>light</i>	Q 71 P 54	Transponder beacon	S 3.1–3.6
Submerged <i>crib</i> <i>duck blind</i> <i>jetty</i> <i>platform</i> <i>production well</i> <i>rock, beacon on</i> <i>well (buoyed)</i> <i>wreck</i>	K i K k F b K l L 20 Q 83 L a K 22–23, 26–30	Tenacious	J aq	Transporter <i>bridge</i> <i>overhead (aerial cableway)</i>	D 24 D 25
Subsidiary light	P 42.1–42.2	Terms relating to tidal levels	H 1–17, a–k	Trap, fish	K 44.2–45, Q i
Subsurface Ocean Data Acquisition System (ODAS)	L 25	Territorial Sea	N 42–43	Traveling crane	F 53.1
Sunken <i>danger (swept)</i> <i>wreck</i>	K f K c	Tidal <i>basin</i> <i>harbor</i> <i>levels</i> <i>stream</i> <i>signal station</i> <i>station</i> <i>table</i> <i>streams and currents</i> <i>table</i>	F 28 F 28 H 1–17, 20 H 1 T 34 H 46 A g, H 31 H 40–47 H 30	Trees <i>height of top</i> <i>types of</i>	C 14 C 31–32, i–k
Superbuoy	Q 26	Tide <i>gauge</i> <i>level terms</i> <i>rips</i>	T 32.1–32.2 H 1–17, a–k H 44	Triangular shaped beacon	Q i
Supply pipeline	L 40.1–40.2			Triangulation point	B 20
				Trot, mooring	Q 42
				True (compass)	B s

Index

Tufa	J n
Tun buoy	Q 25
Tunnel <i>pipeline</i>	D 16 L 42.2
Tunney nets <i>area</i>	K 44.2–45 K 45
Turbine <i>wind</i> <i>underwater</i>	E 26.1, L 5.1 L 24
Two-way <i>route</i> <i>track</i>	M 27.2, 28.1–28.2 M 4, 5.2
Tyfon	R 13
Types of <i>fog signals</i> <i>seabed, intertidal areas</i>	R 10–16 J 20–22
U	
Ultra quick light	P 10.8
Uncovers	K 11, 21, h
Under construction	D d, F 30–32
Underwater <i>installations</i> <i>rock</i> <i>turbine</i>	L 20–25 K 13–15 L 24
Uneven	J bf
Unexploded ordinance	K p
Units	A b, B 40–54
University	E h
Unsurveyed <i>coastline</i> <i>depths</i>	C 2 I 25
Unwatched, unmanned light	P 53, e
Update	A 7
Upper light	P 22
Urban area	D 1
V	
Variation, magnetic	B 68.1–71, p
Varied	J be
Various limits	N 60.1–65
Vegetation	C 30–33, i–t
Velocity	H n

Vertical <i>clearance</i> <i>color striped</i> <i>lights</i>	D 22, 23.1, 23.4, 23.6–28 Q 5 P 15
Vertically disposed	P 15
Very quick light	P 10.7
Vessel, light	P e
Viaduct	D f
Views	E 3.1–3.2
Village	D 4
Violet	J at, P 11.5
Virtual AIS	S 18.1–18.7
Visitor's <i>berth</i> <i>mooring</i>	F 19.2 Q 45
Volcanic <i>ash</i>	J 37 J k
Volcano	K d
W	
Wall, training	F 5
Warehouse	F 51
Water <i>discolored</i> <i>features</i> <i>intake</i> <i>pipeline</i> <i>pipeline area</i> <i>tank</i> <i>tower</i>	K e C 20–25 L 41.1–41.2, b L 40.1, 41.1 L 40.2, L 41.2 E 21 E 21
Waterfalls	C 22
Watermill	E c
Wave <i>actuated fog signal</i> <i>farm</i>	R 21–22 L 6
Way point	M 40.1
Weather signal station	T 29
Weed	J 13.1–13.2
Weir, fish	K 44.2
Well <i>submerged</i> <i>suspended</i> <i>production</i>	E e L a L 21 L 20
Wellhead	L 21.1–21.2, 23
West <i>cardinal mark</i>	B 12 Q 130.3

Wet dock	F 27
Wharf	F 13
Whistle <i>buoy</i>	R 15 Q c
White	J ar, P 11.1
Wind <i>farm</i> <i>signal station</i> <i>turbine</i>	E 26.2, L 5.2 T 29 E 26.1, L 5.1
Windmill	E 25.1–25.2
Withy	Q 91–92
Woodland <i>coniferous</i> <i>deciduous</i>	C j C i
Woods, wooded	C 30
Works <i>at sea, (reclamation area)</i> <i>on land</i> <i>under construction, works in progress</i>	F 31 F 30 F 32
World Geodetic System (WGS)	S 50
Wreck <i>buoy (marking new danger)</i> <i>mast</i>	K 20–30, c Q 130.7 K 25
Y	
Yacht <i>berths without facilities</i> <i>club</i>	F 11.2 F 11.3
Yard <i>timber</i>	B d F 52
Yellow	J aw, P 11.6
Z	
Zone <i>Exclusive Economic Zone (EEZ)</i> <i>fishing</i> <i>inshore traffic</i> <i>seaward, contiguous</i> <i>separation</i>	N 47 N 45 M 25.1–25.2 N 44 M 13, 20.1–20.3

Appendix 1 IALA Maritime Buoyage System

Region A Lateral Marks



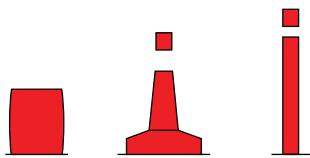



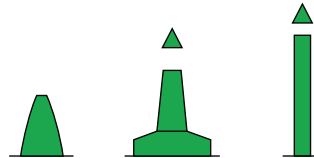

Port Hand



Starboard Hand



red	Color	green
cylindrical (can), pillar, spar	Buoy	conical (nun), pillar, spar
single red cylinder (can)	Topmark (if any)	single green cone, point upward

Lights (if any): may have any phase characteristic other than that used for preferred channels		
	Quick Flashing	
	Flashing	
	Long Flashing	
	Group Flashing	

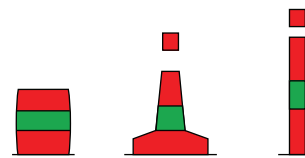

Preferred Channel
to Starboard

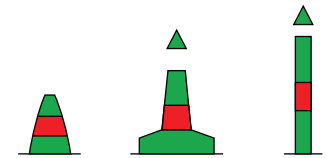

Preferred Channel
to Port



red with one green horizontal band	Color	green with one red horizontal band
cylindrical (can), pillar, spar	Buoy	conical (nun), pillar, spar
single red cylinder (can)	Topmark (if any)	single green cone, point upward

Lights (if any) are composite group flashing		
	FI (2+1)	

Region B Lateral Marks



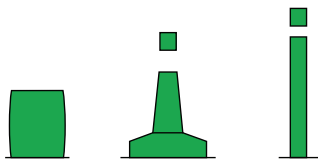



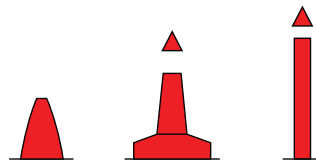

Port Hand



Starboard Hand



green	Color	red
cylindrical (can), pillar, spar	Buoy	conical (nun), pillar, spar
single green cylinder (can)	Topmark (if any)	single red cone, point upward

Lights (if any): may have any phase characteristic other than that used for preferred channels		
	Quick Flashing	
	Flashing	
	Long Flashing	
	Group Flashing	

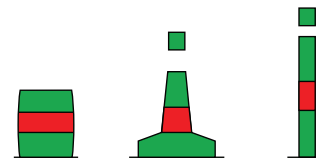

Preferred Channel to Starboard

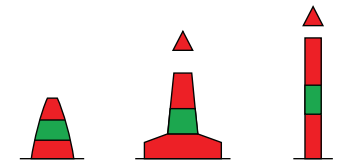

Preferred Channel to Port



green with one red horizontal band	Color	red with one green horizontal band
cylindrical (can), pillar, spar	Buoy	conical (nun), pillar, spar
single green cylinder (can)	Topmark (if any)	single red cone, point upward

Lights (if any) are composite group flashing		
	FI (2+1)	

Appendix 1 IALA Maritime Buoyage System

Cardinal Marks in Regions A and B

Lights, when fitted, are white

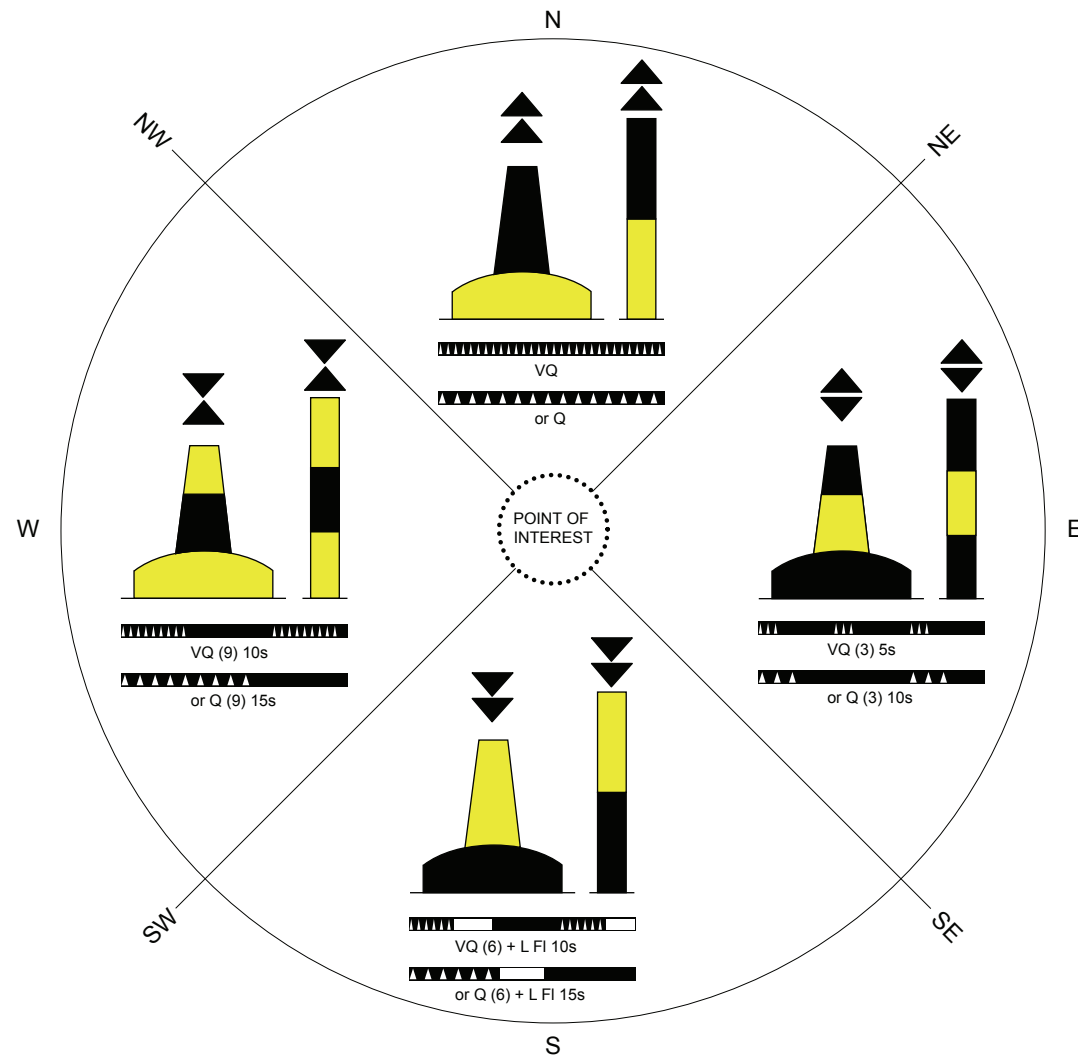

Regions A and B

Isolated Danger Marks

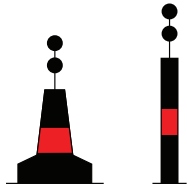

Color	black with one or more red horizontal band(s)
Buoy	optional, but not conflicting with lateral marks; pillar or spar preferred
Topmark (if any)	always fitted with double spheres

Lights (if any)	
Color	white
Rhythm	group flashing

Safe Water Marks

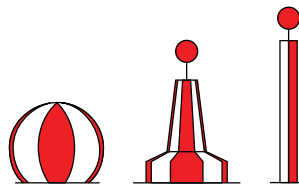

Color	red and white vertical stripes
Buoy	spherical, pillar or spar
Topmark (if any)	single red sphere

Lights (if any)	
Color	white
ISO	
Oc	
L Fl 10s	
Morse "A"	

Special Marks

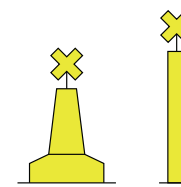

Color	yellow
Buoy	optional, but not conflicting with lateral marks
Topmark (if any)	single yellow "X" shape

Lights (if any)	
Color	yellow
Fl Y	
Fl (4) Y	
May have any rhythm other than those used for white lights on cardinal, isolated danger or safe water marks.	

New Danger Marks

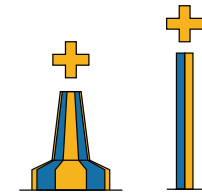

Color	blue and yellow vertical stripes
Buoy	pillar or spar
Topmark (if any)	vertical/perpendicular yellow cross

Lights (if any)	
Color	alternating blue and yellow
Al Oc Bu Y 3s	

